

Panasonic

PanClima

Air Conditioning & Heating Systems



COMMERCIAL PACI RANGE

2025 / 2026

PANASONIC TOTAL SOLUTION



heating & cooling solutions

Product quality and safety

All Panasonic air conditioners undergo strict quality and safety tests before sale. This rigorous process includes obtaining all necessary safety approvals, to ensure that all air conditioners we sell are not only built to the highest market standards, but are also completely safe.



Professional air conditioners with R32 refrigerant.

R32
GWP REDUCED BY
75%

Panasonic recommends R32, with lower Global Warming Potential (GWP). Compared to R22 and R410A, R32 has a low potential impact on global warming. Panasonic takes action in helping to protect the environment. In line with the European countries participating in the Montreal Protocol, protecting the ozone layer and preventing global warming, Panasonic is leading the switch to R32.

Installation innovation.

- Extremely easy to install, practically the same as R410A
- Single substance refrigerant, which makes it easier to recycle and reuse

Environmental innovation.

- Zero impact on the ozone layer
- 75% less impact on global warming

Economic and energy consumption innovation.

- Lower cost and greater savings
- Higher energy efficiency than R410A

PACi NX Elite: Top-tier commercial air conditioning.

The PACi NX Elite range has been expanded to include the Big PACi NX models 20,0-25,0 kW.

Outstanding performance at extreme ambient temperatures with very high energy efficiency both in heating and cooling. Fans, fan motors, compressors and heat exchangers engineered for maximum savings result in higher seasonal efficiencies, which ranks as one of the best in the industry, ensuring reduced CO₂ emissions, energy consumption and operating costs.

From 3,6 to 25,0 kW.

- Meeting all necessary approvals to ensure quality and safety
- Top class SEER: 8,9 A+++ / SCOP: 5,1 A+++ at 3,6 kW (in 90x90 cassette)
- A compact outdoor unit featuring a single fan across all the capacities
- Long piping allowance, maximum 100 m ¹⁾
- Wide operation range, up to 52 °C in cooling and down to -20 °C in heating
- Auto restart after power outage
- Twin, triple and double-twin connections
- Water Heat Exchanger ²⁾ and AHU connection compatibility

1) For models 10,0 - 25,0 kW. 2) For models 20,0 - 20,5 kW.



PACi NX Standard: For economy and value.

With high quality design and engineering, the PACi NX Standard are the perfect solutions for projects which demand quality on a limited budget. In addition, compact and lightweight design makes them ideal for installations with limited space including small commercial and residential applications. The slim and lightweight outdoor unit design enables installation even in very challenging locations.

From 2,5 to 14,0 kW.

- Extended range of outdoor units starting from 2,5 kW
- Great balance of system cost and performance
- Top class SEER / SCOP in the standard Inverter category
SEER: 8,1 A++ / SCOP: 4,8 A++ at 3,6 kW (in 90x90 cassette)
- Variety of individual and central controllers which provides full flexibility
- Compact outdoor units, small footprint and lightweight
- Twin connection possible from 10,0 to 14,0 kW
- Operation range, up to 43 °C in cooling and down to -15 °C in heating



PACi NX Series. The next generation is here

NX Series with R32 refrigerant has been developed to meet the demand of easy refurbishment with 3 wire method.

Integrated with IoT solutions and includes nanoe™ X function as standard.



1 PACi NX Series for absolute ease of refurbishment

This series have been developed with 3 wire power and communication. It makes it simple and easy to replace old systems with 3 wire connections, which is prevalent in many systems.

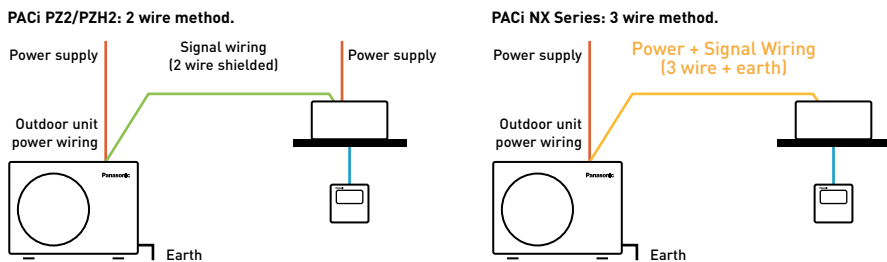

2 CONEX with IoT integration

The wired remote controller series is fully integrated with IoT solutions developed by Panasonic. Detailed operation, maintenance setting and service operation are all possible with smartphone or tablet.

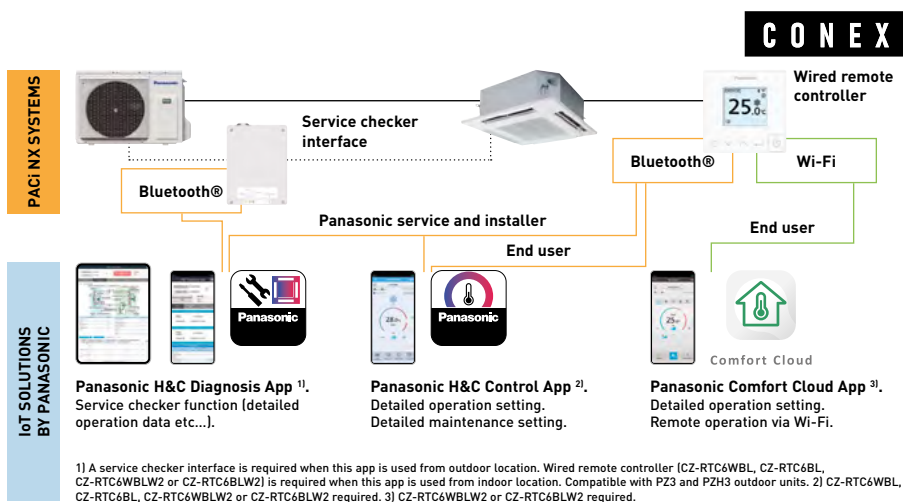

3 Let Panasonic take care of indoor air quality

Thanks to the nanoe™ X properties, several types of pollutants can be inhibited such as certain types of bacteria, viruses, mould, allergens, pollen and certain hazardous substances. This unique technology is equipped to provide better air quality whether residential or commercial.



7 effects of nanoe™ X - Panasonic unique technology.

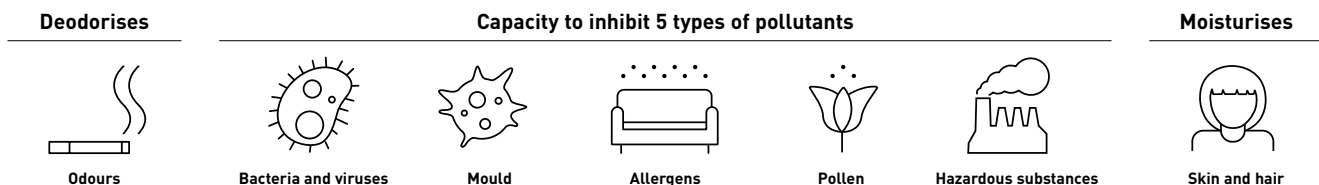

The nanoe™ X performance varies depending on the room size, environment and usage and it may take several hours to reach the full effect. nanoe™ X is not medical device, local regulations on building design and sanitary recommendations must be followed.

➤ REFER TO PAGE 14 FOR MORE DETAILS AND VALIDATION DATA

4 Increasing the efficiency

The PACi NX Series have improved seasonal efficiencies in both heating and cooling versus the previous generation.

Energy class ¹⁾ and seasonal efficiency value ($\eta_{s,c} / \eta_{s,h}$) ²⁾													
Wall-mounted - PK4		4 way cassette - PY3		4 way cassette - PU3		Ceiling - PT3		Adaptive ducted - PF3		Hide-away - PE4			
Elite	Standard	Elite	Standard	Elite	Standard	Elite	Standard	Elite	Standard	Elite	Standard	Elite	Standard
kW		2,5		3,6		5,0		6,0		7,1		10,0	
A++ A+		A++ A+		A+++ A++ A+ A+		A+++ A++ A+ A+		A+++ A++ A+ A+		A+++ A++ A+ A+		A+++ A++ A+ A+	
12,5		14,0		20,0		25,0		20,0		25,0		20,0	
304,3%		186,0%		267,0%		157,0%		278,4%		175,6%		241,7%	
147,4%		142,6%		142,6%		142,6%		281,7%		165,0%		257,4%	
142,6%		142,6%		142,6%		142,6%		275,9%		162,6%		252,2%	
142,6%		142,6%		142,6%		142,6%		275,9%		162,6%		252,2%	
237,8%		146,0%		237,8%		146,0%		237,8%		146,0%		237,8%	
213,0%		145,0%		213,0%		145,0%		213,0%		145,0%		213,0%	

1) Energy label scale from A+++ to D for models below 12,0 kW (EU regulation 626/2011). 2) $\eta_{s,c} / \eta_{s,h}$ values for models above 12,0 kW (EN 14825).

PACi NX Elite Series 4



The compact chassis newly designed with one fan up to 25,0 kW, will fit in limited installation space.

- A compact outdoor unit featuring a single fan across all the capacities up to 25,0 kW
- With the unit weighting only 66 kg*, it is easy to carry and easy to install

* For model 7,1 kW.



PACi NX Elite from 7,1 to 14,0 kW

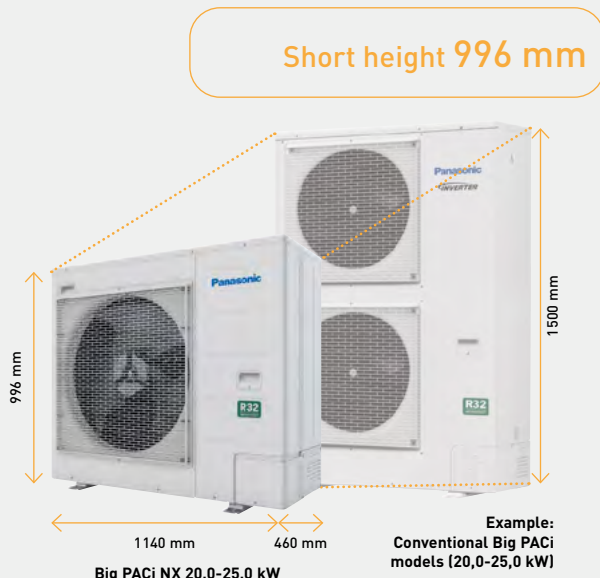

Highly efficient performance in a compact body

One fan outdoor units keep the excellent seasonal performance by optimizing the layers of the heat exchanger. As a result, PZH4 Series provide the equivalent high seasonal performance to conventional 2 fan models.

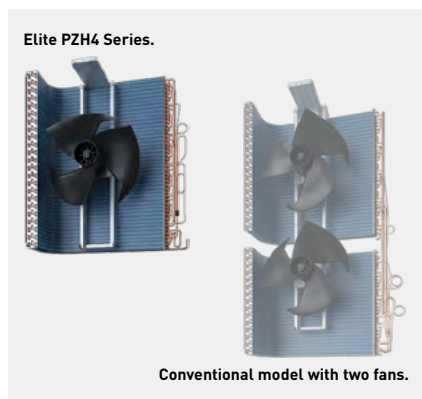

PZH4 Series seasonal performance.

SEER / SCOP

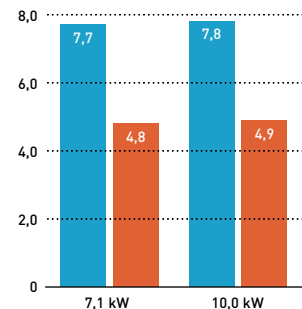

$\eta_{s,c} / \eta_{s,h}$

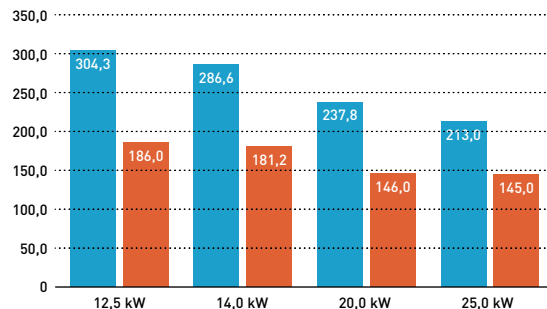

* Performance tested with a 4 way 90x90 cassette for 7,1 to 14,0 kW and a high static pressure hide-away 20,0-25,0 kW.

Extended operation range up to 52 °C in cooling and down to -20 °C in heating

Upgraded PACi NX Elite Series are capable of working even in the challenging ambient conditions. Cooling operation is possible when outdoor temperature is as low as -20 °C* or as high as 52 °C. Heating operation can also be utilized at outdoor temperatures down to -20 °C when outdoor temperature is as low as -20 °C.

* For models 10,0 – 14,0 kW with pipe length up to 30 m.

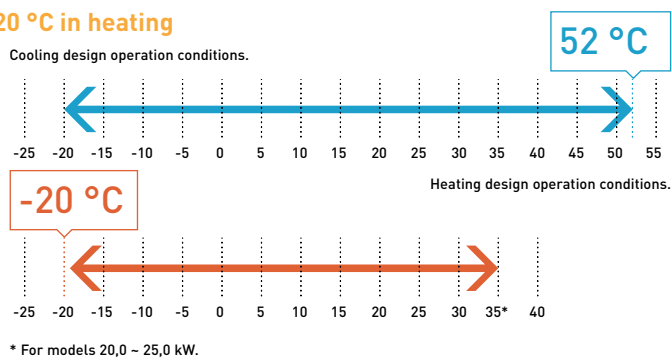

Long piping allowance maximum 100 m*

Increased piping length gives great design flexibility to adapt various building types and sizes. Piping length: 100 m (10,0 to 25,0 kW), 60 m (7,1 kW)

* For models 10,0 – 25,0 kW.

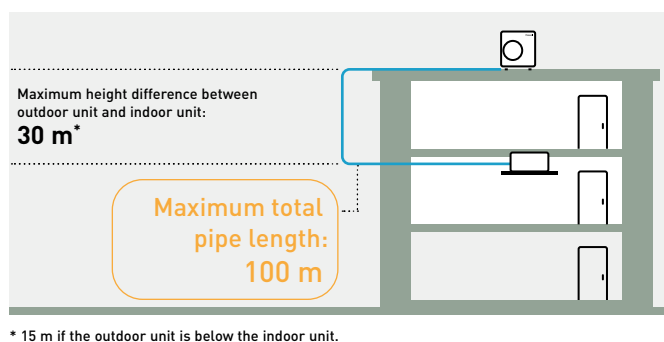

* 15 m if the outdoor unit is below the indoor unit.

CONEX. Devices and apps

CONEX provides comfort and control for varying user needs. Accessible, flexible and scalable with different controllers and apps. Perfectly meeting requirements of modern controls for end user, installer and service.



Comfort Cloud



- 1 Intuitive control with stylish design**
- Simple operation at a glance
 - Clean face with full flat and LCD display
 - Compact body, only 86x86 mm

- 2 Control comfort with your smartphone**
- Flexible control options with IoT integration
 - Panasonic H&C Control App for daily remote control operation
 - Panasonic Comfort Cloud App for remote operation 24/7/365

- 3 Easy maintenance with service support app**
- Quick and easy app set-up for system setting
 - Panasonic H&C Diagnosis App enables the user to obtain detailed system operation data
- * The use of apps depends on the remote controller model.

CONEX with IoT integration



The wired remote controller series is fully integrated with IoT solutions developed by Panasonic. Detailed operation, maintenance setting and service operation are all possible with smartphone or tablet.

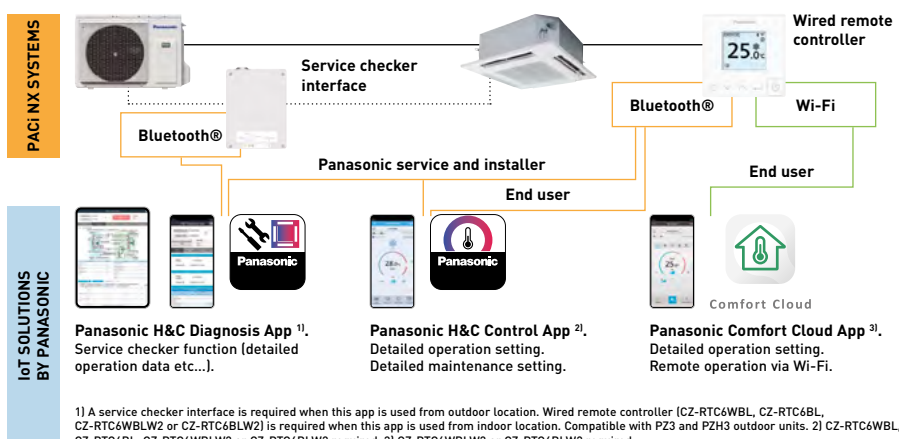
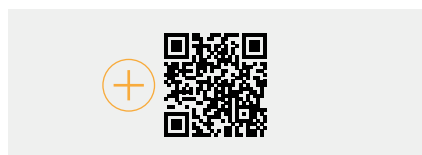

White model	CZ-RTC6W	CZ-RTC6WBL	CZ-RTC6WBLW2
Black model	CZ-RTC6	CZ-RTC6BL	CZ-RTC6BLW2
Wired connection compatible with	PACi NX, ECOi, GHP	PACi NX, ECOi, GHP	PACi NX only
Wireless functions	No wireless capability	Bluetooth®	Bluetooth® + Wi-Fi
App compatibility			
Panasonic Comfort Cloud App	—	—	✓
Panasonic H&C Control App	—	✓ PACi NX, ECOi, GHP	✓ PACi NX only
Panasonic H&C Diagnosis App ¹⁾	—	✓ PACi NX only ²⁾	✓ PACi NX only ²⁾
Outdoor unit settings (remote controller connected to indoor unit)	✓ PACi NX only ²⁾	✓ PACi NX only ²⁾	✓ PACi NX only ²⁾

1) Compatible with U-71/100/125/140PZH3E5/8 and U-100/125/140PZ3E5/8. 2) When connected to PACi NX indoor and outdoor unit combination.

Commercial Wi-Fi Adaptor

Panasonic CZ-CAPWFC2 interface adaptor, allows connection of one or a group of indoor units to Panasonic Comfort Cloud App, which provides control, monitoring, scheduling, and error alerts.

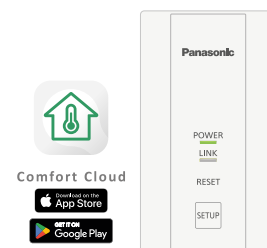

Advanced smartphone control

Control PACi NX, ECOi, and ECO G indoor units with your smartphone whenever and wherever you are, by using Panasonic Comfort Cloud App and Commercial Wi-Fi Adaptor. This scalable solution is ideal for one system, one site or multiple locations. Coupling the adaptor with the already feature rich systems, makes it an ideal solution for residential and commercial applications.

1 From 1 to 200 units
User can control up to 10 different sites, with up to 20 units / groups per site. Additionally, one adaptor can be connected to 1 indoor or to a group of up to 8 indoors.

2 Voice control compatible
Registering the unit to Panasonic Comfort Cloud App makes it compatible with the most popular voice assistants.

3 Multi user
The Panasonic Comfort Cloud App allows multi-user access control, whilst allowing user restriction to specific units.

4 Easy scheduling
Complex weekly scheduling made simple. Not only for one unit, but across multiple sites, and from a smartphone.

5 Energy monitor
See the estimated power consumption and compare with other periods, to see how energy consumption can be further reduced. Check list of units that provides consumption*.

6 Error codes
Error code notification through the App, provides early notification and allows for faster repair.

* Function available depending on the model.

Connection diagram

Commercial Wi-Fi Adaptor wiring length is 1,9 m and connects to indoor unit via T10 connector and R1/R2 terminal connectors.

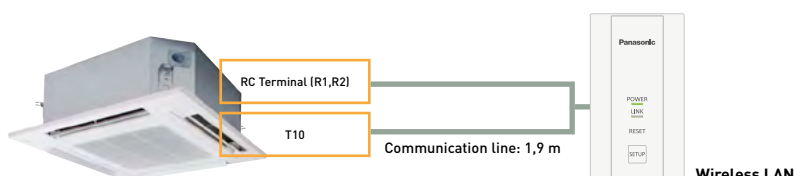

Download free app: Panasonic Comfort Cloud App.

Other hardware requirements: Router and Internet (purchase and subscribe separately). Panasonic Cloud Server is designed, operated and managed by Panasonic.



Comfort Cloud



Download on the App Store



GET IT ON Google Play

Input Voltage	12 V DC (supplied from T10 connector)
Power Consumption	Maximum 2,4 W
Size (HxWxD)	120 x 70 x 25 mm
Weight	190 g (including communications lines)
Interface	1 x Wireless LAN
Wireless LAN Standard	IEEE 802,11 b/g/n
Frequency Range	2,4 GHz band
Operating range	0 ~ 55 °C, 20 ~ 80 RH%
Connectable indoor unit	1 unit
Length of communication line	1,9 m (included)

Bringing nature's balance indoors



nanoe™ X, technology with the benefits of hydroxyl radicals.

Abundant in nature, hydroxyl radicals (also known as OH radicals) have the capacity to inhibit pollutants, viruses, and bacteria to clean and deodorise. nanoe™ X technology can bring these incredible benefits indoors so that hard surfaces, soft furnishings, and the indoor environment can be a cleaner and more pleasant place to be, whether at home, work, or visiting hotels, shops and restaurants etc.



What is unique about nanoe™ X?

Effective on fabrics and surfaces.

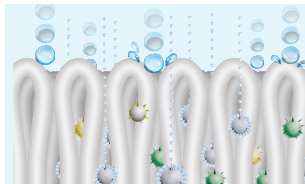

1 | At one billionth of a metre, nanoe™ X is much smaller than steam and can deeply penetrate cloth fabrics to deodorise.

Longer lifespan.



2 | Contained in tiny water particles, nanoe™ X has a long lifespan, which is about 600 seconds, to spread easily around the room.

Huge quantity.



3 | nanoe X Generator Mark 3 produces 48 trillion hydroxyl radicals per second. Greater amounts of hydroxyl radicals contained in nanoe™ X lead to higher performance on inhibition of pollutants.

Maintenance-free.

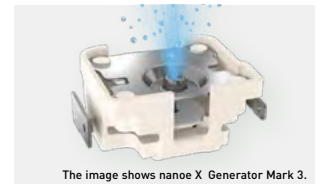

The image shows nanoe X Generator Mark 3.

4 | No service and maintenance required. nanoe™ X is a filter free solution that does not require maintenance, as its atomisation electrode is enveloped with water during its generation process and it is made with Titanium.

7 effects of nanoe™ X - Panasonic unique technology

Deodorises

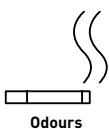

Odours

Capacity to inhibit 5 types of pollutants

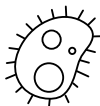

Bacteria and viruses



Mould



Allergens



Pollen



Hazardous substances



Skin and hair

* Refer to <https://aircon.panasonic.eu> for more details and validation data.

First nanoe™ device was developed by Panasonic in 2003

Generator: nanoe™

2003

480 billion hydroxyl radicals/sec

Ion particle structure

Hydroxyl radicals

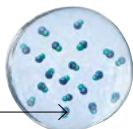

Generator: nanoe™ X

Mark 1 - 2016

4,8 trillion hydroxyl radicals/sec

10x times

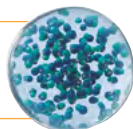

Mark 2 - 2019

9,6 trillion hydroxyl radicals/sec

20x times

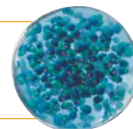

Mark 3 - 2022

48 trillion hydroxyl radicals/sec

100x times

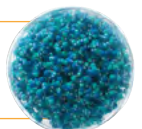

nanoe™ X, internationally-validated technology in testing facilities.

The effectiveness of nanoe™ X technology has been tested by 3rd party laboratories in Germany, France, Denmark, Japan and China.

The nanoe™ X performance varies depending on the room size, environment and usage and it may take several hours to reach the full effect. nanoe™ X is not medical device, local regulations on building design and sanitary recommendations must be followed. Test results conducted under controlled laboratory conditions. Performance of nanoe™ X might differ in real life environment.

	Tested contents	Generator	Result	Capacity	Time	Testing organisation	Report No.	
Airborne	Virus	Influenza (H1N1)	98,3% inhibited	30 m³	1,5 h	China Electronic Product Reliability and Environmental Testing Research Institute	J2003WT8888-00889	
		Bacteriophage ΦX174	99,2% inhibited	Approx. 25 m³	6 h	Kitasato Research Center for Environmental Science	24_0300_1	
	Bacteria	Staphylococcus aureus	99,7% inhibited	Approx. 25 m³	4 h	Kitasato Research Center for Environmental Science	24_0301_1	
Adhering	Virus	SARS-CoV-2	91,4% inhibited	6,7 m³	8 h	Texcell (France)	1140-01 C3	
		SARS-CoV-2	99,9% inhibited	45 L	2 h	Texcell (France)	1140-01 A1	
		Bacteriophage ΦX174	99,8% inhibited	Approx. 25 m³	8 h	Japan Food Research Laboratories	13001265005-01	
		Xenotropic murine leukemia virus	99,999% inhibited	45 L	6 h	Charles River Biopharmaceutical Services GmbH	—	
		Coxsackie virus (CA16)	99,9%inhibited	30 m³	4 h	China Electronic Product Reliability and Environmental Testing Research Institute	J2002WT8888-00439	
		Bacteriophage	Mark 3	98,81% inhibited	Approx. 139,3 m³	4 h	SGS Inc	SHES210901902584
	Bacteria	Staphylococcus aureus	MS2 Phage Virus	Mark 3	99,99% inhibited	Approx. 25 m³	Shokukanen, Inc.	227131N
			Staphylococcus aureus	Mark 1	99,9% inhibited	20 m³	Danish Technological Institute	868988
	Pollen	Cedar pollen	Ambrosia pollen	Mark 1	99,4% inhibited	20 m³	Danish Technological Institute	868988
			Ambrosia pollen	Mark 1	99%inhibited	Approx. 24 m³	Panasonic Product Analysis Center	H21YA017-1
	Odours	Cigarette smoke odour	Mark 1	Odour intensity reduced by 2,4 levels	Approx. 23 m³	0,2 h	Panasonic Product Analysis Center	4AA33-160615-N04
			Mark 3	Odour intensity reduced 1,7 levels	Approx. 139,3 m³	0,5 h	SGS Inc	SHES210901902478

Licensed in VDI 6022

Certification of a HVAC system under VDI 6022 guarantees that the system fulfills the market's strictest hygiene requirements.



VDI 6022 - Part 5 ¹⁾ Certification.
Avoidance of allergenic exposure.
 Inhibits a wide range of harmful bacteria, viruses, mould, pollen and allergens.



VDI 6022 - Part 1 ¹⁾ & 1.1 ²⁾ Certification.
Ventilation and indoor-air quality.
 Panasonic nanoe™ X technology improving indoor air quality.

1) Certification mark only valid for nanoe X Generator Mark 3. 2) Certification mark only valid for nanoe X Generator Mark 2 and Mark 3.

nanoe™ X: improving protection 24/7.

Acts to clean your air, so that the indoor environment can be a cleaner and more pleasant place to be all day long. nanoe™ X works together with heating or cooling function when you are at home and can work independently when you are away. Give the air conditioning the strength to increase the protection at home with nanoe™ X technology and convenient control via the Panasonic Comfort Cloud App.

Cleans the air when you are away.
 Leave the nanoe™ mode ON to inhibit certain pollutants and deodorise before you return home.

Improves your environment when you are at home.
 Enjoy a cleaner, comfortable space with loved ones.

Panasonic Heating & Cooling Solutions is incorporating nanoe™ technology in a wide range of equipment

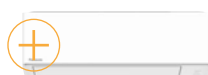

Wall-mounted.
Built-in nanoe X Generator Mark 3.



Ceiling.
Built-in nanoe X Generator Mark 2.



4 Way 60x60 cassette.
Built-in nanoe X Generator Mark 2.



Adaptive ducted unit.
Built-in nanoe X Generator Mark 2.



4 Way 90x90 cassette.
Built-in nanoe X Generator Mark 1.



High static pressure hide-away.
Built-in nanoe X Generator Mark 3.



Ceiling mounted air-e nanoe X Generator.
Built-in nanoe X Generator Mark 1.

PACi NX 4 way 90x90 cassette - PU3

These cassettes offer upgraded nanoe™ X and Econavi technologies to make the room air more comfortable and healthy and to increase the energy efficiency.



1 Improved indoor air quality with nanoe™ X and fresh air intake

- nanoe™ X technology equipped as standard for improved indoor air quality
- Internal cleaning function for the unit with nanoe™ X
- High external fresh air intake volume with optional kit (CZ-FDU3 + CZ-ATU2)

2 Superior energy efficiency and comfort

- High seasonal efficiency both in heating and cooling, maximum SEER: 8,9 A+++ / SCOP: 5,1 A+++*
- Econavi: Intelligent sensors to increase energy savings and comfort
- Super Quiet operation down to 27 dB(A)

* For 3,6 kW model.

3 Easy installation

- Light weight, easy piping and integrated drain pump for quick installation
- Wired remote controller CZ-RTC6WBL and CZ-RTC6BL allows easy system setting via Bluetooth®



White and graphite black panels available, offering versatile options for commercial applications.

+ SEE PRODUCT SPECIFICATIONS



Standard panel, white (RAL9003). CZ-KPU3



Standard panel, graphite black (RAL9011). CZ-KPU3

Econavi panel, white (RAL9003). CZ-KPU3A

Always fresh and clean air with nanoe™ X

The 4 way 90x90 cassette with nanoe™ X, when tested, has shown to inhibit hazardous substances by 92%, when compared to natural reduction*. In addition to the 7 effects of nanoe™ X, the indoor unit can also be cleaned with a short operation of nanoe™ X + dry mode.

* Controllers (CZ-RTC5B, CZ-RTC6W/BL/BLW2 or CZ-RTC6/BL/BLW2) are required.

After cooling/drying operation, the inside of the indoor unit is automatically dried and nanoe™ X is activated to suppress mould growth.

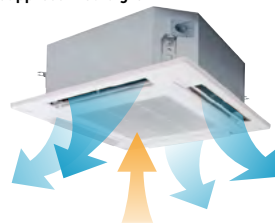

Operates the fan to discharge internal humidity.

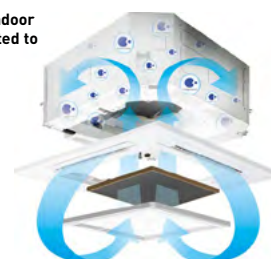

Operate the fan to circulate nanoe™ X internally.

nanoe™ X effect against odour proven in large space

92% of hexadecane ¹⁾ is inhibited after 8-hours exposure in room side 267 m².

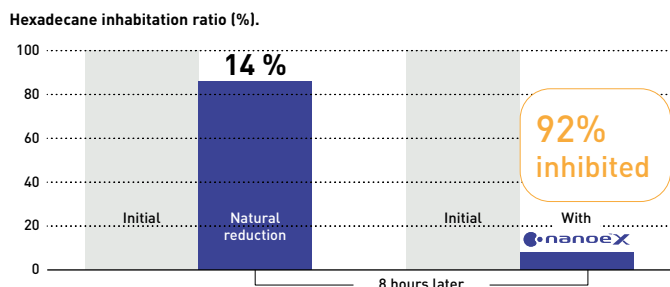

Test ambient.

3rd party certification organization SIRIM ²⁾ conducted the performance experiment of 4 way cassette equipped with nanoe X Generator Mark 1 device in inhibiting hexadecane, a chemical contaminant.

1) Hexadecane is a hazardous substance contained in gasoline and diesel exhaust gas, and considered to be one cause of oil odour. 2) SIRIM Berhad (SIRIM), a premier industrial research and technology organization in Malaysia, wholly-owned by the Ministry of Finance Incorporated.

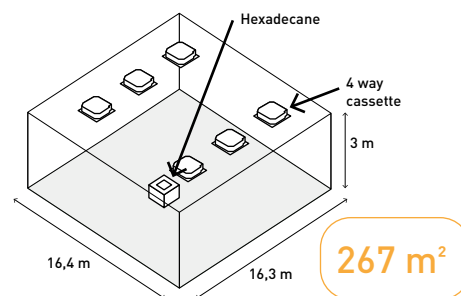

Optional Econavi intelligent sensor

Human activity sensor and floor temperature sensor can reduce waste energy, by optimising air conditioner operation.

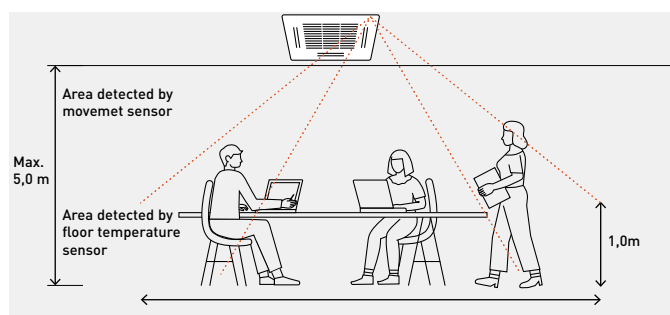

Advanced Econavi functions.

2 sensors (movement and floor temperature) can provide a reduction in wasted energy by means of effective control. The floor temperature can be detected with a ceiling height of up to 5 m.



Econavi exclusive panel. Optional (CZ-KPU3A)

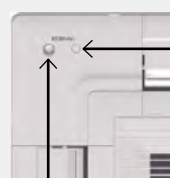

Floor temperature sensor. This sensor detects average floor temperature and operates circulation if floor temperature is low.

Movement sensor. This sensor detects the amount of human activity, and operates effectively.



Wired remote controller CZ-RTC5B, CZ-RTC6W/BL/BLW2 or CZ-RTC6/BL/BLW2 is required.

PACi NX adaptive ducted unit - PF3

The adaptive ducted units provide better flexibility with both installation possibilities, horizontal and vertical. The powerful external static pressure, maximum 150 Pa.





[+ SEE PRODUCT SPECIFICATIONS](#)

1 Highly flexible installation
2 installation possibilities (horizontal / vertical).

2 High seasonal performance with slim body
Maximum SEER: 7,4 A++¹⁾ / SCOP: 4,7 A++²⁾.
1) For 10,0 kW model. 2) For 7,1 kW model.

3 Comfort operation
· Super Quiet operation, minimum 22 dB(A)*
· Optimized IAQ solutions for different target objectives. nanoe™ X and the BION air pollutant filter (optional)

* 3,6 kW model and when operating with external static pressure 50 Pa in low fan mode.

2 installation possibilities (horizontal / vertical)

Vertical installation is available. External static pressure 150 Pa, sufficient for remotely installing units away from the rooms.



Improved drain pan design

Just one drain pan for both horizontal and vertical installations. No need to modify the unit.

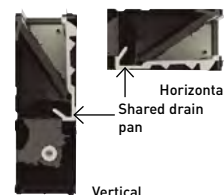

Selectable inlet air position

Inlet air position may be adjusted by means of a removable panel, to allow rear or bottom entry, depending on the duct installation.

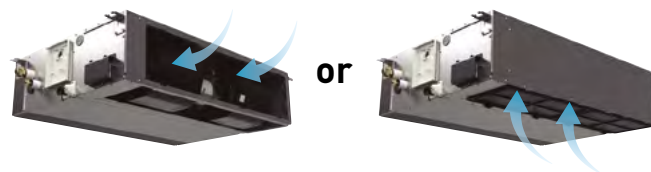

Maximum efficiency

Energy class ¹⁾ and seasonal efficiency value ($\eta_{s,c} / \eta_{s,h}$) ²⁾	kW	$\eta_{s,c}$					$\eta_{s,h}$	
		3,6	5,0	6,0	7,1	10,0	12,5	14,0
Elite		A++	A++	A++	A++	A++	281,7%	275,9%
		A+	A+	A++	A++	A+	170,0%	171,0%
Standard		A+	A++	A++	A++	A++	257,4%	252,2%
		A+	A+	A++	A+	A	142,6%	140,6%

1) Energy label scale from A+++ to D for models below 12,0 kW (EU regulation 626/2011). 2) $\eta_{s,c} / \eta_{s,h}$ values for models above 12,0 kW (EN 14825).

Compact body

- Only 250 mm high
- Light units from 25 to 39 kg

Conventional model	Adaptive ducted
33 kg	30 kg
290 mm	250 mm



Better indoor air quality with nanoe™ X

The performance of nanoe™ X technology is maintained, even with 10 m long ducts*. The effect of improved air quality is sufficient to allow for numerous duct shapes to fit the application.

* Panasonic internal survey.

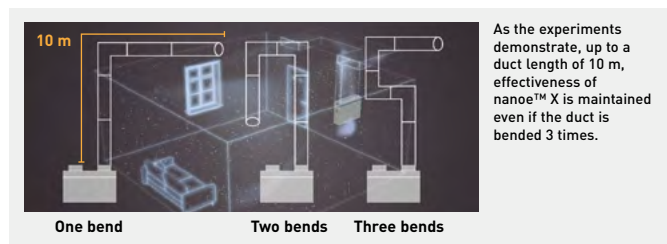

nanoe™ X effect against odour proven in large space

In a room of 139 m², tobacco odour is reduced by a factor of 0,7 when compared to natural reduction over a period of 2 hours.

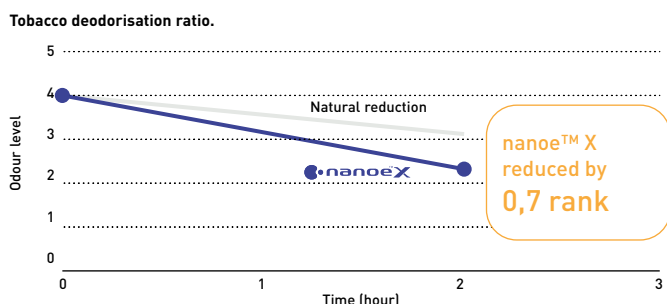

Test ambient.
3rd party international testing institute KAKEN¹⁾ conducted the performance experiment of Adaptive ducted equipped with nanoe™ X Generator Mark 2 device removing tobacco odour.

1) KAKEN TEST CENTER General Incorporated Foundation in Japan, international testing institute.

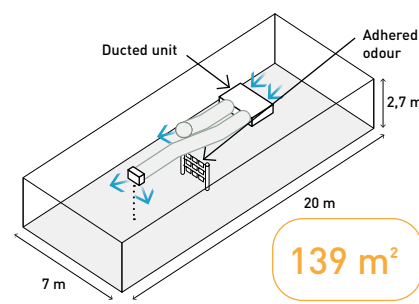

PACi NX wall-mounted, 4 way 60x60 cassette and ceiling



A new era of air conditioning solutions are here, with built-in nanoe™ X technology.



[+ SEE PRODUCT SPECIFICATIONS](#)

PACi NX wall-mounted - PK4.

Equipped with the upgraded nanoe™ X (Generator Mark 3) for improved indoor air quality. It's modern, flat design with a stylish matte white finish complements any interior, while improved fan serviceability ensures effortless maintenance.

Modern design for any interior

Its modern, flat design with a stylish matte white finish suits any interior, perfect for commercial projects.

Air distribution is automatically altered depending on the operational mode of the unit

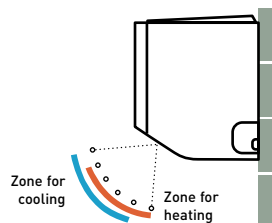

Piping outlet in six directions

Piping outlet is possible in six directions of; right, right rear, right bottom, left, left rear and left bottom, making the installation work more flexible.



Efficient installation with drain hose support holders and lock mechanism

Easy connection and disconnection of the drain hose. Locking mechanism between the drain tray and hose ensures a tight connection during installation and easy dismantling.



Built-in support holders for secure spacing. Holds the indoor unit against the wall, providing clear access for setting up the drain hose and piping.





+ SEE PRODUCT SPECIFICATIONS

PACi NX 4 way 60x60 cassette - PY3.

The PY3 not only perfectly matches with 600 x 600 mm ceiling grids but also provides an additional benefit for better indoor quality, with nanoe™ X built-in.

Industry-leading energy efficiency

- Energy class A++* with Elite outdoor range
- Energy class A++ with Standard outdoor range 2,5 kW model

* Except for 6,0 kW.

Internal cleaning function

When cooling or dry operation stopped, internal drying and nanoe™ X circulation air flow is activated in order to suppress the mould proliferation inside the unit (air flow passage, fan, heat exchanger)*.

* Depending on the installation environment or operating hours, mould proliferation or inhabitation of mould growth will be changed.

Compact and stylish design

- Required ceiling depth of only 250 mm
- Exposed area is only 30 mm

Individual flap control

Better control of the air flow with 4 motors, providing individual flap control.

Perfect air distribution without direct air flow, to reduce the feeling of cold drafts.

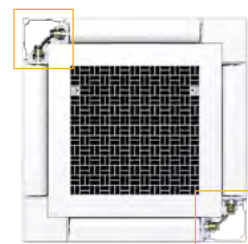

+ SEE PRODUCT SPECIFICATIONS

PACi NX ceiling - PT3.

Providing outstanding energy-saving performance, comfort and long-distance air flow distribution, these units are perfect for retail stores and schools.

Comfortable, long-distance air flow distribution

The shape of the outlet has been optimised to provide long-distance air flow distribution.

Even in long rooms, air flow reaches every corner for exceptionally comfortable air conditioning.

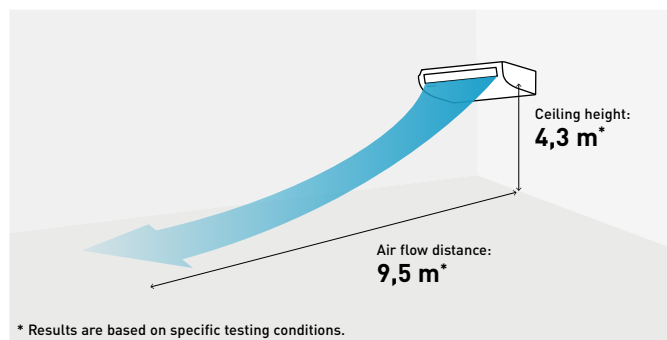

* Results are based on specific testing conditions.

Compact looking, stylish, one-motion design

With its streamlined, one-motion form, the unit looks thin and compact when installed for a neat appearance in any room. When not operating, the louver closes to provide an elegant look while also keeping the unit clean.

Energy-saving technology delivering top-class efficiency

Optimisation of the shape of the casing and fan assures bigger air flow and higher efficiency. Energy-saving performance is top class in the industry. Thanks to new DC fan motor and large diagonal air flow fan.

Big PACi NX high static pressure hide-away 20,0-25,0 kW - PE4

The split-able indoor unit design facilitates easy piping work. nanoe™ X technology equipped as standard for improved indoor air quality.





[+ SEE PRODUCT SPECIFICATIONS](#)

1 Compact and light indoor body
Compact and light indoor body, keeping the high efficiency, has a split-able design for easy installation within a limited narrow space. Plus ease of maintenance due to the simplified disassembly design.

3 High external static pressure, maximum 200 Pa* setting
A high static pressure enables the use of long ducts for installation in a wide range of spaces.
* For model S-250PE4E.

2 Easy pipe work with split-able hide-away indoor design
Heat exchanger and fan elements (fan + casing) can be separated during installation. The hide-away indoor unit is easily reassembled and will fit through a narrow space.

4 Comfort operation

- nanoe™ X as standard for improved indoor air quality
- Smartphone control-ready with the Panasonic Comfort Cloud App ¹⁾

1) Panasonic Wi-Fi Adaptor CZ-CAPWFC2 is required.

Improved indoor air quality with nanoe™ X
The nanoe™ X technology is now available for the Big PACi NX range from 20,0-25,0 kW. The PE4 model is equipped with Generator Mark 3, generating 48 trillion hydroxyl radicals/sec, specifically designed to accommodate long duct piping applications.



Maximum 200 Pa* static pressure setting
A high static pressure enables the use of long ducts for installation in a wide range of spaces.



3-step static pressure set up.
Selectable of static pressure modes can change 200 Pa / 130 Pa / 75 Pa for extra installation flexibility.

* For model S-250PE4E.

Easy installation with light components
Indoor unit can easily be split into 3 components, the heaviest of which weighs only 48 kg.

Dimensions of each component (lightweight design for easy disassembly).

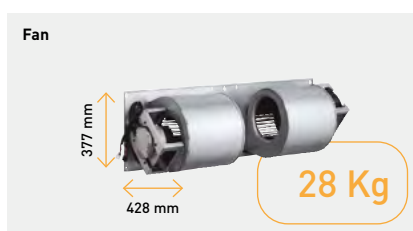
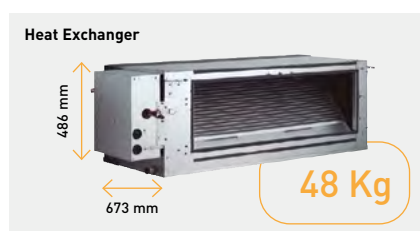

The weight is for S-250PE4E model.

Jet Air Stream

Large spaces are often heated with boilers and unit heaters, which are inefficient, noisy, complex, and expensive fossil fuel systems that rarely offer summer cooling integration. The Jet Air Stream provides an efficient and sustainable solution for year-round heating and cooling in large spaces. It ensures optimal user comfort, a quiet environment, and is much easier to install than other systems.



Efficient heating and cooling.

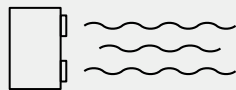

Long air distribution.

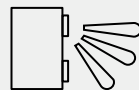

Smart Jet - self-directing nozzles.



Quiet operation.



The Jet Air Stream for the large spaces that require high air distribution, such as gymnasiums, production areas and warehouses.

[+ SEE PRODUCT SPECIFICATIONS](#)

High air distribution for large spaces

High air volume with a long air flow distance of up to 30 m ensures optimal comfort for large spaces like warehouses and gyms.

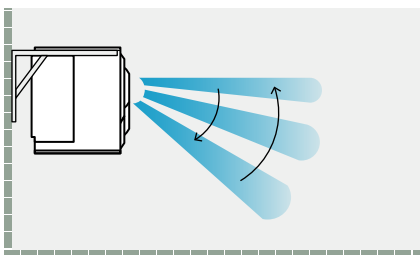
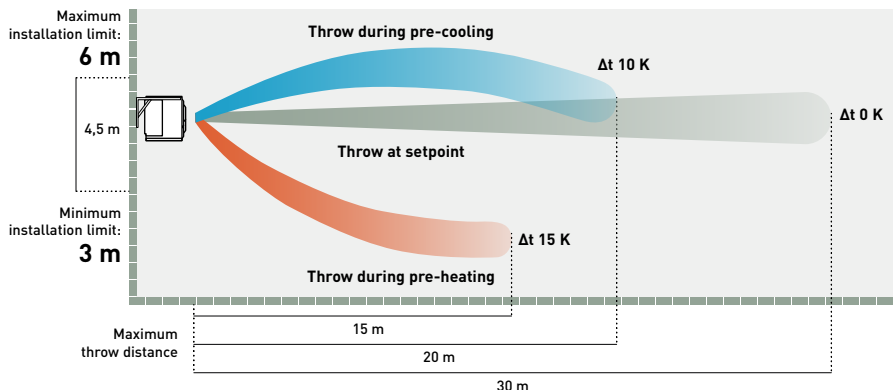

Smart Jet - self-directing nozzles

Jet Air Stream Smart models ensure optimal comfort by preventing heat loss. Nozzle movements adapt dynamically to incoming air temperature, preventing stratification and maintaining an ideal temperature exclusively in the occupied area.

Jet Air Stream operation

In cooling mode, the nozzle operation logic is inverted until the setpoint is reached

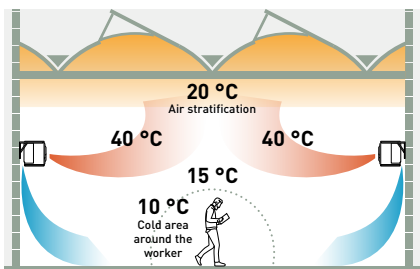

Existing solution in heating. Air stratification occurs when warm air from the heating system rises to the top of the room, while cold air stays at the bottom. This is due to warm air being lighter and rising, and cooler air being denser and staying low.

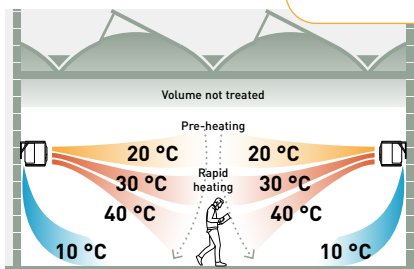

Jet Air Stream operation in heating. Pre-heating: Upon start-up, the Jet Air Stream Smart directs the nozzles horizontally, preventing not-yet-warm air from blowing on people. Rapid heating: Once the air reaches the ideal temperature, power is maximised and the nozzles point downward, ensuring rapid heating of the occupied area.

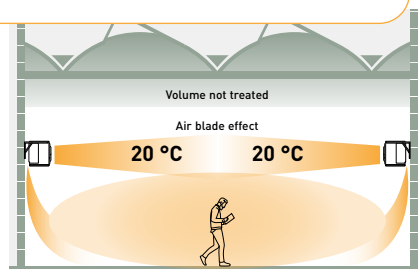

Jet Air Stream operation in heating. Maintenance with air blade effect: Jet Air Stream Smart adjusts power once the desired temperature is reached. This aligns nozzles horizontally, creating an 'air blade' as a thermal barrier to optimise heat distribution and prevent upward dispersion.

Type	Jet Air Stream Smart		Jet Air Stream Standard		Jet Air Stream Ducted		
Air flow	m ³ /h	2500 m ³ /h	5000 m ³ /h	2500 m ³ /h	5000 m ³ /h	2500 m ³ /h	5000 m ³ /h
Model		P-VTVF140MC5-PE	P-VTVF250MC5-PE	P-VTVF140NC5-PE	P-VTVF250NC5-PE	P-VTVF140PC5-PE	P-VTVF250PC5-PE
Image	Smart Jet - self-directing nozzles		Manual nozzles		Ducted front panel		
Compatible outdoor unit		U-140PZH4E5/8	U-250PZH4E8	U-140PZH4E5/8	U-250PZH4E8	U-140PZH4E5/8	U-250PZH4E8

Solutions for server rooms applications

Effectively protect your IT related spaces, 24/7, with a complete range of solutions offering redundancy control. High efficiency products provide reliable cooling all year round.



YKEA server room solution.

- Perfect solution for smaller server rooms
- Compact design
- Reaching SEER value of 9,6 (A+++)¹⁾
- High seasonal performance
- Range of capacities available
- Operation down to -25 °C ambient

¹⁾ For 3,5 kW unit.

PACi NX solution.

- Scalability for larger applications
- Twin, triple and double-twin options¹⁾
- Increased piping lengths of up to 90 m²⁾
- Increased sensible capacity options available
- Flexible and adaptable control options

¹⁾ Compatible with PAW-PACR4 only. ²⁾ For Big PACi NX 20 kW unit.

Redundancy ensured by three different functionalities.

Computer and server rooms are very sensitive areas of application. Any downtime caused by high room temperatures must be avoided by any means. Air conditioner redundancy is one of the key points to ensure a reliable nonstop cooling operation.

1 Backup operation

When an air conditioner fails for whatever reason, another one will awake from standby mode and cover the room's cooling load.

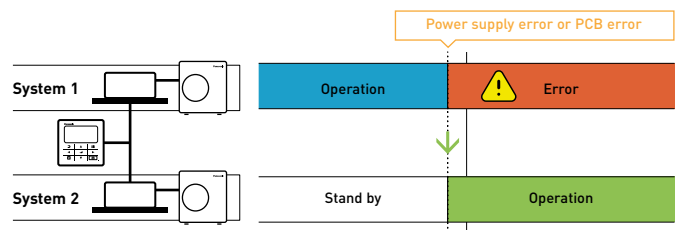

2 Support operation

Support operation, also called cascade control, makes sure that the capacity required to cool the room is delivered by one or more units whenever required. When the capacity of 1 air conditioner is not sufficient, another one will be started to support the operation.

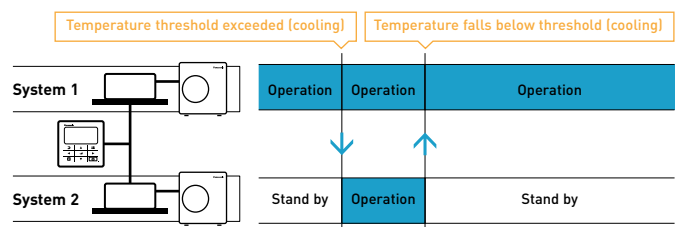

3 Rotation operation

Backup and support operation are key functions for a redundant operation in computer rooms. This concept implies a main system and a sub system. In order to avoid an imbalance of the operating hours of the systems, the redundancy control equalises the operation time by rotating the main and the sub systems, thus providing a "rotation operation".

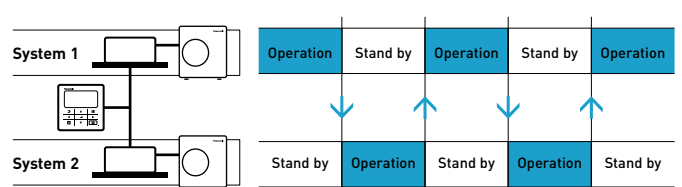

Redundancy control options for 24/7/365 applications

YKEA integral solution

- Ideal solution for small server rooms, providing full redundancy functionality integrated in YKEA's remote controller (requires optional CZ-RCC5 cable set)
- Up to 2 YKEA systems connectable to 1 remote controller
- Individual alarm display for each system
- Operation can be monitored by Panasonic Comfort Cloud App (via WLAN)
- No digital inputs/outputs

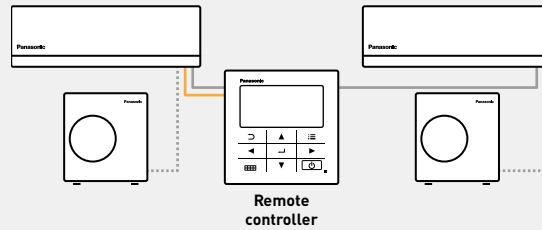

Optional interface for YKEA units

PAW-SERVER-PKEA

- Ideal solution for small server rooms, providing full redundancy functionality
- Up to 2 YKEA systems connectable to PAW-SERVER-PKEA
- Additional benefits: Operation and alarm outputs for each system, ON / OFF inputs for each system for connection to external BMS

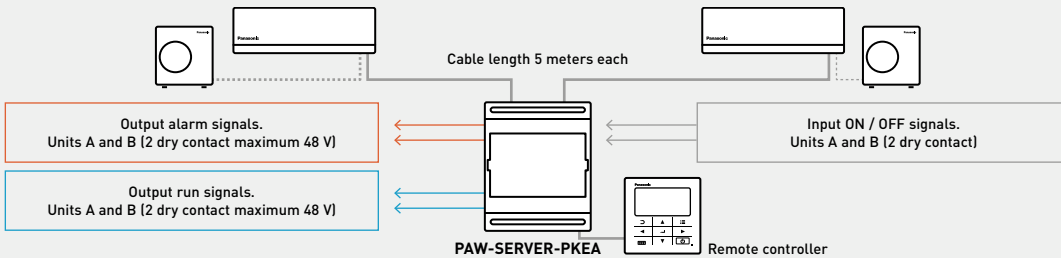

PACi NX integral solution

CZ-RTC5B / CZ-RTC6W / CZ-RTC6 / CZ-RTC6WBL / CZ-RTC6BL / CZ-RTC6WBLW2 / CZ-RTC6BLW2

- Full redundancy functionality
- Quick and easy installation using PACi NX group control
- Up to 2 PACi NX systems connectable to 1 remote controller
- Delta T setting for support operation selectable from 4 to 10 K
- Connectable to Panasonic centralised control systems
- Optional interfaces for connection to external BMS (Modbus, BACnet, KNX)

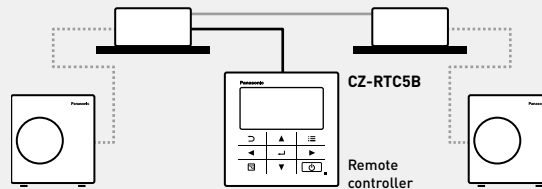

Optional interface up to 4 indoor units PACi NX or VRF





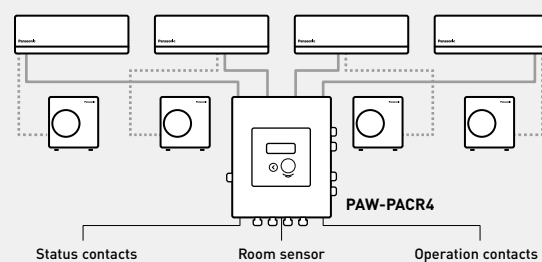









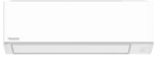
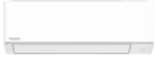
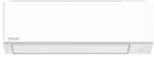















PAW-PACR4

- Redundancy control up to 4 indoor unit groups
- Actual unit operation / alarm status can be displayed
- Common digital alarm / operation status output
- For each support operation level, individual temperature thresholds can be set (cascade control)
- Room temperature display (by device's own temperature sensor)
- Modbus connection (up to 4 PAW-RC2-MBS-1)
- Available external inputs (ON / OFF, heating/cooling change*, fire prevention contact)



* External input heating/cooling change only for the interface control logic, not for the indoor unit mode change.

Commercial units range

Indoor units	2,5 kW	3,6 kW	4,5 kW ¹⁾	5,0 kW	6,0 kW
Wall-mounted Professional · R32 ²⁾	 CS-Z25YKEA-1	 CS-Z35YKEA-1	 CS-Z42YKEA-1	 CS-Z50YKEA-1	
NEW PACi NX wall-mounted · R32	 S-2545PK4E	 S-2545PK4E	 S-2545PK4E	 S-5010PK4E	 S-5010PK4E
PACi NX 4 way 60x60 cassette · R32	 S-25PY3E	 S-36PY3E	 S-50PY3E	 S-60PY3E	
PACi NX 4 way 90x90 cassette · R32		 S-3650PU3E	 S-3650PU3E	 S-3650PU3E	 S-6071PU3E
PACi NX ceiling · R32		 S-3650PT3E	 S-3650PT3E	 S-3650PT3E	 S-6071PT3E
PACi NX adaptive ducted · R32		 S-3650PF3E	 S-3650PF3E	 S-3650PF3E	 S-6071PF3E
Big PACi NX high static pressure hide-away 20-25 kW · R32					
PACi NX Jet Air Stream · R32					
Outdoor units	2,5 kW	3,6 kW	5,0 kW	6,0 kW	
PACi NX Elite · R32 Big PACi NX (20,0-25,0 kW) · R32		 U-36PZH3E5	 U-50PZH3E5	 U-60PZH3E5	
PACi NX Standard · R32	 U-25PZ3E5	 U-36PZ3E5	 U-50PZ3E5	 U-60PZ3E5A	

1) The 4,5 kW indoor capacity options are only available only for twin, triple and double-twin combinations. 2) Not compatible with PACi NX outdoors and accessories. Domestic range sales conditions may apply. Check with your sales representative.

* U-__E5 Single phase / U-__E8 Three phase.

 OPTIONAL UNITS ON VENTILATION SECTION

7,1 kW

10,0 kW

12,5 kW

14,0 kW

20,0 kW

25,0 kW



CS-Z71YKEA-1



S-5010PK4E



S-5010PK4E



S-6071PU3E



S-1014PU3E



S-1014PU3E



S-1014PU3E

A new panel in graphite black (RAL9011) is available.



S-6071PT3E



S-1014PT3E



S-1014PT3E



S-1014PT3E



S-6071PF3E



S-1014PF3E



S-1014PF3E



S-1014PF3E



S-200PE4E



S-250PE4E

P-VTVF140MC5-PE /
P-VTVF140NC5-PE /
P-VTVF140PC5-PEP-VTVF250MC5-PE /
P-VTVF250NC5-PE /
P-VTVF250PC5-PE

7,1 kW

10,0 kW

12,5 kW

14,0 kW

20,0 kW

25,0 kW



U-71PZH4E5 / U-71PZH4E8



U-100PZH4E5 / U-100PZH4E8



U-125PZH4E5 / U-125PZH4E8



U-140PZH4E5 / U-140PZH4E8



U-200PZH4E8

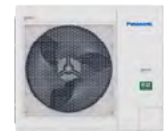

U-250PZH4E8



U-71PZ3E5A



U-100PZ3E5 / U-100PZ3E8



U-125PZ3E5 / U-125PZ3E8



U-140PZ3E5 / U-140PZ3E8

YKEA series for server rooms

High efficiency products for 24/7 applications. Panasonic has developed a complete range of solutions for server rooms which efficiently protect your servers, keeping them at an appropriate temperature even when the outdoor temperature is below $-25\text{ }^{\circ}\text{C}$.



1 Designed for 24h/7d a week operation

High efficiency all year round. This wall-mounted air conditioner is designed for professional, critical applications such as computer rooms where reliable cooling inside the room is necessary even with extreme ambient conditions.

3 Highest energy rating in cooling

The SEER and SCOP of the Server room unit has been further improved to achieve top class energy efficiency. The 3,5 kW unit reaches now the SEER value of 9,6 (A+++).

2 Remote controller for better usability

Wired remote controller, which can assure the operation 24/7 of two server room units, thanks to the integrated duty rotation mode. This function manages rotation and backup of two units and it is available when connecting an optional CN-CNT cable (CZ-RCC5) between the controller and each of the two indoor units.

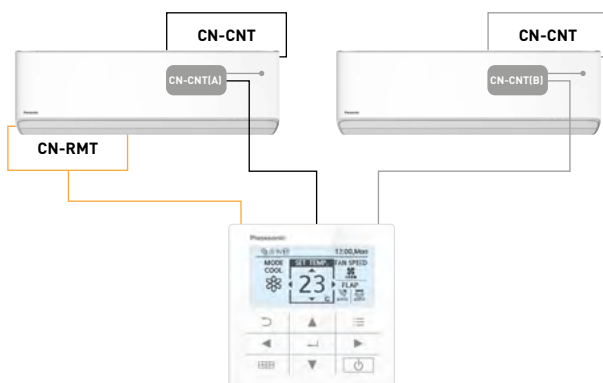

4 Built-in Wi-Fi and compatible with Voice Assistant

The unit is ready to connect to the internet and to be controlled by smartphone with Panasonic Comfort Cloud App. Control, monitor energy consumption statistics and easily identify errors in case of failure.



Not compatible with PACi NX outdoors and accessories. Domestic range sales conditions may apply. Check with your sales representative.

Wall-mounted Professional -25 °C · R32

- Designed for 24h/7d a week operation
- Wired remote controller, with optional duty rotation mode
- Improved SEER / SCOP to achieve top class energy efficiency
- Aerowings 2.0, for a better control of the air flow
- Built-in Wi-Fi for smart control via Panasonic Comfort Cloud App
- Compatible with Google Assistant and Amazon Alexa
- Chassis and parts designed for easier installation



Kit			KIT-Z25-YKEA-1	KIT-Z35-YKEA-1	KIT-Z42-YKEA-1	KIT-Z50-YKEA-1	KIT-Z71-YKEA-1
Cooling capacity	Nominal (Min - Max)	kW	2,50 (0,85 - 3,50)	3,50 (0,85 - 4,20)	4,20 (0,85 - 5,00)	5,00 (0,98 - 6,00)	7,10 (0,98 - 8,50)
EER ¹⁾	Nominal (Min - Max)	W/W	4,90 (4,72 - 3,98)	4,12 (4,72 - 3,68)	3,82 (4,72 - 3,25)	3,68 (3,92 - 3,16)	3,23 (2,33 - 2,83)
SEER ²⁾			9,5 A+++	9,6 A+++	8,6 A+++	8,6 A+++	6,5 A++
Pdesign		kW	2,50	3,50	4,20	5,00	7,10
Input power	Nominal (Min - Max)	kW	0,51 (0,18 - 0,88)	0,85 (0,18 - 1,14)	1,10 (0,18 - 1,54)	1,36 (0,25 - 1,90)	2,20 (0,42 - 3,00)
Annual energy consumption ³⁾		kWh/a	92	128	171	203	382
Heating capacity	Nominal (Min - Max)	kW	3,40 (0,85 - 5,00)	4,00 (0,85 - 5,80)	5,30 (0,85 - 6,80)	5,80 (0,98 - 8,00)	8,20 (0,98 - 10,20)
Heating capacity at -7 °C		kW	3,05	3,40	4,11	4,80	6,31
COP ¹⁾	Nominal (Min - Max)	W/W	4,86 (4,72 - 3,97)	4,44 (4,72 - 3,87)	3,93 (4,72 - 3,66)	4,08 (4,26 - 3,35)	3,71 (2,45 - 3,29)
SCOP ²⁾			4,6 A++	4,6 A++	4,5 A+	4,6 A++	4,1 A+
Pdesign at -10 °C		kW	2,70	3,20	3,60	4,20	5,50
Input power	Nominal (Min - Max)	kW	0,70 (0,18 - 1,26)	0,90 (0,18 - 1,50)	1,35 (0,18 - 1,86)	1,42 (0,23 - 2,39)	2,21 (0,40 - 3,10)
Annual energy consumption ³⁾		kWh/a	822	974	1120	1278	1878
Indoor unit			CS-Z25YKEA-1	CS-Z35YKEA-1	CS-Z42YKEA-1	CS-Z50YKEA-1	CS-Z71YKEA-1
Power supply		V	230	230	230	230	230
Recommended fuse		A	16	16	16	16	20
Connection indoor / outdoor		mm ²	4x1,5	4x1,5	4x1,5	4x2,5	4x2,5
Air flow	Cool / Heat	m ³ /min	11,4 / 13,8	12,7 / 14,8	13,2 / 15,2	17,4 / 19,1	19,0 / 19,9
Moisture removal volume		L/h	1,5	2,0	2,4	2,8	4,1
Sound pressure ⁴⁾	Cool (Hi / Lo / Q-Lo)	dB(A)	39/25/21	42/28/21	43/32/29	44/37/30	47/38/35
	Heat (Hi / Lo / Q-Lo)	dB(A)	41/27/22	43/30/22	44/35/29	44/37/30	47/38/35
Sound power	Cool / Heat (Hi)	dB(A)	55/57	58/59	59/60	60/60	63/63
Dimension	H x W x D	mm	295 x 870 x 229	295 x 870 x 229	295 x 870 x 229	295 x 1040 x 244	295 x 1040 x 244
Net weight		kg	11	11	11	12	13
Outdoor unit			CU-Z25YKEA-1	CU-Z35YKEA-1	CU-Z42YKEA-1	CU-Z50YKEA-1	CU-Z71YKEA-1
Air flow	Cool / Heat	m ³ /min	27,6 / 27,6	29,8 / 29,8	29,8 / 31,0	39,8 / 36,9	44,7 / 45,8
Sound pressure ⁴⁾	Cool / Heat (Hi)	dB(A)	46 / 48	48 / 50	48 / 51	48 / 50	52 / 54
Sound power	Cool / Heat (Hi)	dB(A)	61 / 63	63 / 65	63 / 66	63 / 65	66 / 68
Dimension ⁵⁾	H x W x D	mm	542 x 780 x 289	542 x 780 x 289	542 x 780 x 289	695 x 875 x 320	695 x 875 x 320
Net weight		kg	30	30	30	40	45
Piping diameter	Liquid	Inch (mm)	1/4 (6,35)	1/4 (6,35)	1/4 (6,35)	1/4 (6,35)	1/4 (6,35)
	Gas	Inch (mm)	3/8 (9,52)	3/8 (9,52)	1/2 (12,70)	1/2 (12,70)	5/8 (15,88)
Pipe length range		m	3 - 20	3 - 20	3 - 20	3 - 30	3 - 30
Elevation difference (in / out)		m	15	15	15	15	20
Pre-charged pipe length		m	7,5	7,5	7,5	7,5	10
Additional gas amount		g/m	10	10	10	15	25
Refrigerant (R32) / CO ₂ Eq.		kg / T	0,89 / 0,60	0,89 / 0,60	0,97 / 0,65	1,13 / 0,76	1,35 / 0,91
Operating range	Cool Min ~ Max	°C	-25 ~ +43	-25 ~ +43	-25 ~ +43	-25 ~ +43	-25 ~ +43
	Heat Min ~ Max	°C	-15 ~ +24	-15 ~ +24	-15 ~ +24	-15 ~ +24	-15 ~ +24

1) EER and COP calculation is based in accordance to EN 14511. 2) Energy Label Scale from A+++ to D. 3) The annual energy consumption is calculated in accordance to EU/626/2011. 4) The sound pressure of the indoor unit shows the value measured of a position 1 m in front of the main body and 0,8 m below the unit. For outdoor unit 1 m in front and 1 m in rear side of main body. The sound pressure is measured in accordance with JIS C 9612. Q-Lo: Quiet mode. Lo: The lowest set fan speed. 5) Add 70 mm for piping port. * Not compatible with PACi NX outdoors and accessories. Domestic range sales conditions may apply. Check with your sales representative.

Accessories

CZ-RCC5	CN-CNT cables x2 for server room application, control of 2 units, rotation, backup, etc.
PAW-WTRAY	Tray for condenser water compatible with outdoor elevation platform

Accessories

PAW-GRDBSE20	Outdoor base ground support for noise and vibration absorption
PAW-GRDSTD40	Outdoor elevation platform 400 x 900 x 400 mm



SEER: For KIT-Z35-YKEA-1. SCOP: For KIT-Z25-YKEA-1, KIT-Z35-YKEA-1 and KIT-Z50-YKEA-1. SUPER QUIET: For KIT-Z25-YKEA-1. INTERNET CONTROL: Built-in Wi-Fi.

Rating conditions: Cooling indoor 27 °C DB / 19 °C WB. Cooling outdoor 35 °C DB / 24 °C WB. Heating indoor 20 °C DB. Heating outdoor 7 °C DB / 6 °C WB. (DB: Dry Bulb; WB: Wet Bulb). Specifications subject to change without notice. For detailed information about ErP / Energy Labelling, please visit our websites www.aircon.panasonic.eu or [www.ptc.panasonic.eu](http://ptc.panasonic.eu).

NEW PACi NX Series Elite wall-mounted - PK4 - R32

The wall-mounted units with stylish matt color can be offered for many applications such as studios, gyms, high ceiling areas and even computer server rooms.

The compact design and flat face ensure discreet installation, even in a small space.



			Single phase				
			3,6 kW	5,0 kW	6,0 kW	7,1 kW	10,0 kW
Kit			KIT-36PK4ZH5	KIT-50PK4ZH5	KIT-60PK4ZH5	KIT-71PK4ZH5	KIT-100PK4ZH5
Remote controller			CZ-RTC5B	CZ-RTC5B	CZ-RTC5B	CZ-RTC5B	CZ-RTC5B
Cooling capacity	Nominal (Min - Max)	kW	3,5(1,2 - 4,0)	5,0(1,2 - 5,6)	6,1(1,2 - 7,1)	7,1(2,2 - 9,0)	9,5(3,1 - 10,5)
EER ¹⁾	Nominal (Min - Max)	W/W	4,43(4,17 - 5,45)	4,10(3,03 - 5,45)	3,74(3,02 - 5,45)	3,76(2,69 - 5,79)	3,41(3,09 - 5,34)
SEER²⁾			7,7 A++	8,0 A++	7,1 A++	6,6 A++	6,6 A++
Pdesign		kW	3,5	5,0	6,1	7,1	9,5
Input power	Nominal (Min - Max)	kW	0,79(0,22 - 0,96)	1,22(0,22 - 1,85)	1,63(0,22 - 2,35)	1,89(0,38 - 3,35)	2,79(0,58 - 3,40)
Annual energy consumption ³⁾		kWh/a	160	219	301	377	504
Heating capacity	Nominal (Min - Max)	kW	4,0(1,2 - 5,0)	5,6(1,2 - 6,5)	7,0(1,2 - 8,0)	7,8(2,0 - 9,0)	9,5(3,1 - 11,5)
Heating capacity at -15 °C ⁴⁾	Max	kW	3,4	5,0	5,1	5,8	8,9
COP ¹⁾	Nominal (Min - Max)	W/W	4,26(3,33 - 5,45)	4,03(3,10 - 5,45)	4,12(3,40 - 5,45)	4,00(3,16 - 5,56)	3,89(3,00 - 5,34)
SCOP²⁾			4,7 A++	4,6 A++	4,7 A++	4,6 A++	4,1 A+
Pdesign at -10 °C		kW	3,1	4,5	4,6	5,2	8,0
Input power	Nominal (Min - Max)	kW	0,94(0,22 - 1,50)	1,39(0,22 - 2,10)	1,70(0,22 - 2,35)	1,95(0,36 - 2,85)	2,44(0,58 - 3,83)
Annual energy consumption ³⁾		kWh/a	924	1369	1370	1583	2731
Indoor unit			S-2545PK4E	S-5010PK4E	S-5010PK4E	S-5010PK4E	S-5010PK4E
Air flow	Hi / Med / Lo	m ³ /min	11,5/9,5/7,0	17,0/15,5/12,0	21,0/19,0/16,5	21,0/19,0/16,5	22,5/20,0/17,5
Moisture removal volume		L/h	1,0	1,6	1,9	2,4	4,4
Sound pressure ⁵⁾	Hi / Med / Lo	dB(A)	41/36/30	41/36/31	47/44/40	47/44/40	49/45/41
Sound power	Hi / Med / Lo	dB(A)	57/52/46	57/52/47	63/60/56	63/60/56	65/61/57
Dimension	HxWxD	mm	290x765x214	295x1060x249	295x1060x249	295x1060x249	295x1060x249
Net weight		kg	9	14	14	14	14
nanoe X Generator			Mark 3	Mark 3	Mark 3	Mark 3	Mark 3
Outdoor unit			U-36PZH3E5	U-50PZH3E5	U-60PZH3E5	U-71PZH4E5	U-100PZH4E5
Power supply		V	220 - 230 - 240	220 - 230 - 240	220 - 230 - 240	220 - 230 - 240	220 - 230 - 240
Current	Cool	A	3,90 - 3,75 - 3,60	5,80 - 5,55 - 5,30	7,65 - 7,30 - 7,00	9,55 - 9,15 - 8,75	13,80 - 13,20 - 12,60
	Heat	A	4,60 - 4,40 - 4,20	6,60 - 6,30 - 6,05	7,90 - 7,55 - 7,25	9,85 - 9,40 - 9,05	12,10 - 11,50 - 11,10
Air flow	Cool / Heat	m ³ /min	34,1/36,4	42,0/42,0	42,0/42,0	62,0/66,0	76,0/70,0
Sound pressure	Cool / Heat (Hi)	dB(A)	43/44	46/48	47/50	48/50	52/52
Sound power	Cool / Heat (Hi)	dB(A)	62/64	64/67	65/69	65/67	69/69
Dimension	HxWxD	mm	695x875x320	695x875x320	695x875x320	996x980x370	996x980x370
Net weight		kg	42	42	43	66	84
Piping diameter	Liquid	Inch (mm)	1/4 (6,35)	1/4 (6,35) ⁶⁾	1/4 (6,35) ⁶⁾	3/8 (9,52)	3/8 (9,52)
	Gas	Inch (mm)	1/2 (12,70)	1/2 (12,70) ⁷⁾	1/2 (12,70) ⁷⁾	5/8 (15,88)	5/8 (15,88)
Pipe length range		m	3 - 40	3 - 40	3 - 40	5 - 60	5 - 100
Elevation difference (in / out) ⁸⁾		m	15/30	15/30	15/30	15/30	15/30
Pre-charged pipe length		m	30	30	30	30	30
Additional gas amount		g/m	15	15	15	30	40
Refrigerant (R32) / CO ₂ Eq.		kg / T	1,13/0,76	1,13/0,76	1,15/0,78	1,95/1,32	2,70/1,82
Operating range	Cool Min ~ Max	°C	-15 ~ +46	-15 ~ +46	-15 ~ +46	-15 ~ +52	-20 ⁹⁾ ~ +52
	Heat Min ~ Max	°C	-20 ~ +24	-20 ~ +24	-20 ~ +24	-20 ~ +24	-20 ~ +24

Technical focus

- Modern, flat design with a stylish matte white finish featuring
- DC fan motor for better efficiency and control
- Five-direction automatic airflow adjustment for cooling and heating
- Six directional piping outlet
- Quiet operation
- nanoe™ X (Generator Mark 3: 48 trillion hydroxyl radicals/sec) as standard for better indoor air quality
- Wired remote control CZ-RTC6WBL and CZ-RTC6BL allows easy system setting via Bluetooth®
- Easy connection and control of external fan or ERV using the connector PAW-FDC on the indoor unit PCB. The external device can be controlled by the remote control of the Panasonic indoor unit

Closed discharge port

When the unit is turned OFF, the flap closes completely to prevent dust getting into the unit and to keep the equipment clean.

Piping outlet in six directions

Piping outlet is possible in six directions of; right, right rear, right bottom, left, left rear and left bottom, making the installation work more flexible.

Air distribution is automatically altered depending on the operational mode of the unit

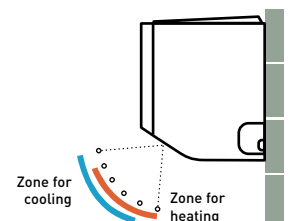

CZ-RTC5B



COMPATIBLE WITH ALL PANASONIC CONNECTIVITY SOLUTIONS. FOR DETAILED INFORMATION GO TO THE CONTROL SYSTEMS SECTION

Optional:



CONE X
CONE X wired remote controller, white.
CZ-RTC6W/BL/BLW2



CONE X
CONE X wired remote controller, black.
CZ-RTC6/BL/BLW2



Infrared remote controller.
CZ-RWS3



Econavi sensor.
CZ-CENSC1

Three phase

			7,1 kW	10,0 kW
Kit			KIT-71PK4ZH48	KIT-100PK4ZH48
Remote controller			CZ-RTC5B	CZ-RTC5B
Cooling capacity	Nominal (Min - Max)	kW	7,1 (2,2 - 9,0)	9,5 (3,1 - 10,5)
EER ¹⁾	Nominal (Min - Max)	W/W	3,76 (2,69 - 5,79)	3,41 (3,09 - 5,34)
SEER ²⁾			6,6 A++	6,6 A++
Pdesign		kW	7,1	9,5
Input power	Nominal (Min - Max)	kW	1,89 (0,38 - 3,35)	2,79 (0,58 - 3,40)
Annual energy consumption ³⁾		kWh/a	377	504
Heating capacity	Nominal (Min - Max)	kW	7,8 (2,0 - 9,0)	9,5 (3,1 - 11,5)
Heating capacity at -15 °C ⁴⁾	Max	kW	5,8	8,9
COP ¹⁾	Nominal (Min - Max)	W/W	4,00 (3,16 - 5,56)	3,89 (3,00 - 5,34)
SCOP ²⁾			4,6 A++	4,1 A+
Pdesign at -10 °C		kW	5,2	8,0
Input power	Nominal (Min - Max)	kW	1,95 (0,36 - 2,85)	2,44 (0,58 - 3,83)
Annual energy consumption ³⁾		kWh/a	1583	2731
Indoor unit			S-5010PK4E	S-5010PK4E
Air flow	Hi / Med / Lo	m ³ /min	21,0/19,0/16,5	22,5/20,0/17,5
Moisture removal volume		L/h	2,4	4,4
Sound pressure ⁵⁾	Hi / Med / Lo	dB(A)	47/44/40	49/45/41
Sound power	Hi / Med / Lo	dB(A)	63/60/56	65/61/57
Dimension	H x W x D	mm	295 x 1060 x 249	295 x 1060 x 249
Net weight		kg	14	14
nanoe X Generator			Mark 3	Mark 3
Outdoor unit			U-71PZH4E8	U-100PZH4E8
Power supply		V	380 - 400 - 415	380 - 400 - 415
Current	Cool	A	3,20 - 3,05 - 3,00	4,65 - 4,45 - 4,20
	Heat	A	3,30 - 3,15 - 3,00	4,05 - 3,85 - 3,70
Air flow	Cool / Heat	m ³ /min	62,0/66,0	76,0/70,0
Sound pressure	Cool / Heat (Hi)	dB(A)	48/50	52/52
Sound power	Cool / Heat (Hi)	dB(A)	65/67	69/69
Dimension	H x W x D	mm	996 x 980 x 370	996 x 980 x 370
Net weight		kg	66	82
Piping diameter	Liquid	Inch (mm)	3/8 (9,52)	3/8 (9,52)
	Gas	Inch (mm)	5/8 (15,88)	5/8 (15,88)
Pipe length range		m	5 - 60	5 - 100
Elevation difference (in / out) ⁸⁾		m	15/30	15/30
Pre-charged pipe length		m	30	30
Additional gas amount		g/m	30	40
Refrigerant (R32) / CO ₂ Eq.		kg / T	1,95/1,32	2,70/1,82
Operating range	Cool Min ~ Max	°C	-15 ~ +52	-20 ⁹⁾ ~ +52
	Heat Min ~ Max	°C	-20 ~ +24	-20 ~ +24

1) EER and COP calculation is based in accordance to EN 14511. 2) For models below 12 kW, the SEER and SCOP is calculated based on values of EU/626/2011. For models above 12 kW, the η_{c} / η_{h} values is calculated based on EN 14825. 3) Factory setting. 4) The value is based on the interpolation. 5) The sound pressure of the units shows the value measured of the position 1 m in front of the main body and 1 m below the unit. The sound pressure is measured in accordance with Eurovent 6/C/006-97 specification. 6) Connect the liquid socket tube (Ø6,35-Ø9,52) to the liquid tubing side indoor unit. 7) Connect the gas socket tube (Ø12,70-Ø15,88) to the gas tubing side indoor unit. 8) Outdoor unit located lower / outdoor unit located higher. 9) Pipe length up to 30 m. * Recommended fuse for the indoor 3 A. ** Above values are in the case of nanoe™ X OFF.

Accessories

CZ-RTC6W	CONE X wired remote controller (non-wireless), white
CZ-RTC6WBL	CONE X wired remote controller with Bluetooth®, white
CZ-RTC6WBLW2	CONE X wired remote controller with Wi-Fi and Bluetooth®, white
CZ-RTC6	CONE X wired remote controller (non-wireless), black
CZ-RTC6BL	CONE X wired remote controller with Bluetooth®, black
CZ-RTC6BLW2	CONE X wired remote controller with Wi-Fi and Bluetooth®, black
CZ-RTC5B	Wired remote controller with Econavi function
CZ-RWS3	Infrared remote controller

Accessories

CZ-CAPWFC2	Commercial Wi-Fi Adaptor
PAW-PACR4	Interface to run up to 4 indoor unit groups on backup and alternative run
PAW-WTRAY	Tray for condenser water compatible with outdoor elevation platform
PAW-GRDBSE20	Outdoor base ground support for noise and vibration absorption
PAW-GRDSTD40	Outdoor elevation platform 400x900x400 mm
CZ-CENSC1	Econavi energy saving sensor



SEER: For S-5010PK4E + U-50PZH3E5. SCOP: For S-2545PK4E + U-36PZH3E5 and S-5010PK4E + U-60PZH3E5. INTERNET CONTROL: Optional.

Rating conditions: Cooling indoor 27 °C DB / 19 °C WB. Cooling outdoor 35 °C DB / 24 °C WB. Heating indoor 20 °C DB. Heating outdoor 7 °C DB / 6 °C WB. (DB: Dry Bulb; WB: Wet Bulb). Specifications subject to change without notice. For detailed information about ErP / Energy Labelling, please visit our websites www.aircon.panasonic.eu or www.ptc.panasonic.eu.

NEW PACi NX Series Standard wall-mounted - PK4 - R32

The wall-mounted units with stylish matt color can be offered for many applications such as studios, gyms, high ceiling areas and even computer server rooms.

The compact design and flat face ensure discreet installation, even in a small space.



			Single phase					
			2,5 kW	3,6 kW	5,0 kW	6,0 kW	7,1 kW	10,0 kW
Kit			KIT-25PK4Z5	KIT-36PK4Z5	KIT-50PK4Z5	KIT-60PK4Z5	KIT-71PK4Z5	KIT-100PK4Z5
Remote controller			CZ-RTC5B	CZ-RTC5B	CZ-RTC5B	CZ-RTC5B	CZ-RTC5B	CZ-RTC5B
Cooling capacity	Nominal (Min - Max)	kW	2,5(1,3-3,9)	3,5(1,3-4,0)	5,0(1,5-5,6)	6,1(2,0-7,1)	6,9(2,6-7,7)	9,0(3,0-9,7)
EER ¹⁾	Nominal (Min - Max)	W/W	4,39(3,68-5,00)	3,89(3,74-5,00)	3,40(3,03-6,25)	3,57(3,01-6,90)	3,29(2,77-5,00)	3,23(3,13-5,36)
SEER²⁾			6,6 A++	6,8 A++	7,2 A++	7,0 A++	6,0 A+	6,2 A++
Pdesign		kW	2,5	3,5	5,0	6,1	6,9	9,0
Input power	Nominal (Min - Max)	kW	0,57(0,26-1,06)	0,90(0,26-1,07)	1,47(0,24-1,85)	1,71(0,29-2,36)	2,10(0,52-2,78)	2,79(0,56-3,10)
Annual energy consumption ³⁾		kWh/a	133	181	243	305	402	508
Heating capacity	Nominal (Min - Max)	kW	2,8(1,3-4,6)	3,6(1,3-4,6)	5,0(1,5-6,4)	6,1(1,8-7,0)	7,1(2,1-8,1)	9,0(3,0-10,5)
Heating capacity at -15 °C ⁴⁾	Max	kW	2,8	2,9	4,4	5,1	5,8	9,7
COP ¹⁾	Nominal (Min - Max)	W/W	4,52(3,54-5,65)	4,09(3,54-5,65)	4,20(3,17-7,50)	4,27(3,18-7,50)	4,10(3,38-6,36)	3,81(3,56-5,36)
SCOP²⁾			4,2 A+	4,4 A+	4,4 A+	4,6 A++	4,4 A+	4,0 A+
Pdesign at -10 °C		kW	2,5	2,6	4,0	4,6	5,2	8,8
Input power	Nominal (Min - Max)	kW	0,62(0,23-1,30)	0,88(0,23-1,30)	1,19(0,20-2,02)	1,43(0,24-2,20)	1,73(0,33-2,40)	2,36(0,56-2,95)
Annual energy consumption ³⁾		kWh/a	833	827	1271	1400	1654	3080
Indoor unit			S-2545PK4E	S-2545PK4E	S-5010PK4E	S-5010PK4E	S-5010PK4E	S-5010PK4E
Air flow	Hi / Med / Lo	m ³ /min	10,5/9,0/7,0	11,5/9,5/7,0	17,0/15,5/12,0	21,0/19,0/16,5	21,0/19,0/16,5	22,5/20,0/17,5
Moisture removal volume		L/h	0,4	1,0	1,6	1,9	2,2	4,0
Sound pressure ⁵⁾	Hi / Med / Lo	dB(A)	39/34/29	41/36/30	41/36/31	47/44/40	47/44/40	49/45/41
Sound power	Hi / Med / Lo	dB(A)	55/50/45	57/52/46	57/52/47	63/60/56	63/60/56	65/61/57
Dimension	HxWxD	mm	290x765x214	290x765x214	295x1060x249	295x1060x249	295x1060x249	295x1060x249
Net weight		kg	9	9	14	14	14	14
nanoe X Generator			Mark 3	Mark 3	Mark 3	Mark 3	Mark 3	Mark 3
Outdoor unit			U-25PZ3E5	U-36PZ3E5	U-50PZ3E5	U-60PZ3E5A	U-71PZ3E5A	U-100PZ3E5
Power supply		V	220-230-240	220-230-240	220-230-240	220-230-240	220-230-240	220-230-240
Current	Cool	A	2,70-2,60-2,45	4,15-4,00-3,85	6,80-6,50-6,25	7,95-7,60-7,25	9,75-9,30-8,95	13,9-13,3-12,8
	Heat	A	2,90-2,80-2,65	4,10-3,95-3,80	5,60-5,35-5,10	6,65-6,35-6,10	8,00-7,70-7,35	11,8-11,3-10,8
Air flow	Cool / Heat	m ³ /min	33,6/34,0	33,6/34,0	32,7/31,9	42,6/41,5	44,7/45,9	73,0/73,0
Sound pressure	Cool / Heat (Hi)	dB(A)	46/47	46/47	46/46	47/48	48/49	52/52
Sound power	Cool / Heat (Hi)	dB(A)	64/66	64/66	64/64	64/65	66/68	70/70
Dimension	HxWxD	mm	619x824x299	619x824x299	619x824x299	695x875x320	695x875x320	996x980x370
Net weight		kg	32	32	35	42	50	83
Piping diameter	Liquid	Inch (mm)	1/4 (6,35)	1/4 (6,35)	1/4 (6,35) ⁶⁾	1/4 (6,35) ⁶⁾	1/4 (6,35) ⁶⁾	3/8(9,52)
	Gas	Inch (mm)	1/2(12,70)	1/2(12,70)	1/2(12,70) ⁷⁾	1/2(12,70) ⁷⁾	5/8(15,88)	5/8(15,88)
Pipe length range		m	3-15	3-15	3-20	3-40	3-40	5-50
Elevation difference (in / out) ⁸⁾		m	15/15	15/15	15/15	15/30	20/30	15/30
Pre-charged pipe length		m	7,5	7,5	7,5	30	30	30
Additional gas amount		g/m	10	10	15	15	17	45
Refrigerant (R32) / CO ₂ Eq.		kg / T	0,87/0,59	0,87/0,59	1,14/0,77	1,15/0,78	1,32/0,89	2,4/1,62
Operating range	Cool Min ~ Max	°C	-10 ~ +43	-10 ~ +43	-10 ~ +43	-10 ~ +43	-10 ~ +43	-10 ~ +43
	Heat Min ~ Max	°C	-15 ~ +24	-15 ~ +24	-15 ~ +24	-15 ~ +24	-15 ~ +24	-15 ~ +24

Technical focus

- Modern, flat design with a stylish matte white finish featuring
- DC fan motor for better efficiency and control
- Five-direction automatic airflow adjustment for cooling and heating
- Six directional piping outlet
- Quiet operation
- nanoe™ X (Generator Mark 3: 48 trillion hydroxyl radicals/sec) as standard for better indoor air quality
- Wired remote control CZ-RTC6WBL and CZ-RTC6BL allows easy system setting via Bluetooth®
- Easy connection and control of external fan or ERV using the connector PAW-FDC on the indoor unit PCB. The external device can be controlled by the remote control of the Panasonic indoor unit

Closed discharge port

When the unit is turned OFF, the flap closes completely to prevent dust getting into the unit and to keep the equipment clean.

Piping outlet in six directions

Piping outlet is possible in six directions of; right, right rear, right bottom, left, left rear and left bottom, making the installation work more flexible.

Air distribution is automatically altered depending on the operational mode of the unit

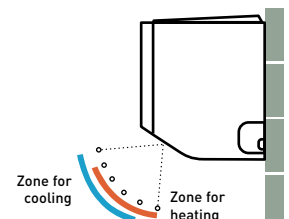

CZ-RTC5B



COMPATIBLE WITH ALL PANASONIC CONNECTIVITY SOLUTIONS. FOR DETAILED INFORMATION GO TO THE CONTROL SYSTEMS SECTION

Optional:



CONEX
CONEX wired remote controller, white.
CZ-RTC6W/BL/BLW2



CONEX
CONEX wired remote controller, black.
CZ-RTC6/BL/BLW2



Infrared remote controller.
CZ-RWS3



Econavi sensor.
CZ-CENSC1

			Three phase
			10,0 kW
			KIT-100PK4Z8
			CZ-RTC5B
Kit			
Remote controller			
Cooling capacity	Nominal (Min - Max)	kW	9,0 (3,0 - 9,7)
EER ¹⁾	Nominal (Min - Max)	W/W	3,23 (3,13 - 5,36)
SEER ²⁾			6,2 A++
Pdesign		kW	9,0
Input power	Nominal (Min - Max)	kW	2,79 (0,56 - 3,10)
Annual energy consumption ³⁾		kWh/a	508
Heating capacity	Nominal (Min - Max)	kW	9,0 (3,0 - 10,5)
Heating capacity at -15 °C ⁴⁾	Max	kW	9,7
COP ¹⁾	Nominal (Min - Max)	W/W	3,81 (3,56 - 5,36)
SCOP ²⁾			4,0 A+
Pdesign at -10 °C		kW	8,8
Input power	Nominal (Min - Max)	kW	2,36 (0,56 - 2,95)
Annual energy consumption ³⁾		kWh/a	3080
Indoor unit			S-5010PK4E
Air flow	Hi / Med / Lo	m ³ /min	22,5 / 20,0 / 17,5
Moisture removal volume		L/h	4,0
Sound pressure ⁵⁾	Hi / Med / Lo	dB(A)	49 / 45 / 41
Sound power	Hi / Med / Lo	dB(A)	65 / 61 / 57
Dimension	H x W x D	mm	295 x 1060 x 249
Net weight		kg	14
nanoe X Generator			Mark 3
Outdoor unit			U-100PZ3E8
Power supply		V	380 - 400 - 415
Current	Cool	A	4,65 - 4,45 - 4,25
	Heat	A	3,95 - 3,75 - 3,60
Air flow	Cool / Heat	m ³ /min	73,0 / 73,0
Sound pressure	Cool / Heat (Hi)	dB(A)	52 / 52
Sound power	Cool / Heat (Hi)	dB(A)	70 / 70
Dimension	H x W x D	mm	996 x 980 x 370
Net weight		kg	83
Piping diameter	Liquid	Inch (mm)	3/8 (9,52)
	Gas	Inch (mm)	5/8 (15,88)
Pipe length range		m	5 - 50
Elevation difference (in / out) ⁸⁾		m	15 / 30
Pre-charged pipe length		m	30
Additional gas amount		g/m	45
Refrigerant (R32) / CO ₂ Eq.		kg / T	2,4 / 1,62
Operating range	Cool Min ~ Max	°C	-10 ~ +43
	Heat Min ~ Max	°C	-15 ~ +24

1) EER and COP calculation is based in accordance to EN 14511. 2) For models below 12 kW, the SEER and SCOP is calculated based on values of EU/626/2011. For models above 12 kW, the η_{c} / η_{h} values is calculated based on EN 14825. 3) Factory setting. 4) The value is based on the interpolation. 5) The sound pressure of the units shows the value measured of the position 1 m in front of the main body and 1 m below the unit. The sound pressure is measured in accordance with Eurovent 6/C/006-97 specification. 6) Connect the liquid socket tube (Ø6,35-Ø9,52) to the liquid tubing side indoor unit. 7) Connect the gas socket tube (Ø12,70-Ø15,88) to the gas tubing side indoor unit. 8) Outdoor unit located lower / outdoor unit located higher. * Recommended fuse for the indoor 3 A. ** Above values are in the case of nanoe™ X OFF.

Accessories

CZ-RTC6W	CONEX wired remote controller (non-wireless), white
CZ-RTC6WBL	CONEX wired remote controller with Bluetooth®, white
CZ-RTC6WBLW2	CONEX wired remote controller with Wi-Fi and Bluetooth®, white
CZ-RTC6	CONEX wired remote controller (non-wireless), black
CZ-RTC6BL	CONEX wired remote controller with Bluetooth®, black
CZ-RTC6BLW2	CONEX wired remote controller with Wi-Fi and Bluetooth®, black
CZ-RTC5B	Wired remote controller with Econavi function
CZ-RWS3	Infrared remote controller

Accessories

CZ-CAPWFC2	Commercial Wi-Fi Adaptor
PAW-PACR4	Interface to run up to 4 indoor unit groups on backup and alternative run
PAW-WTRAY	Tray for condenser water compatible with outdoor elevation platform
PAW-GRDBSE20	Outdoor base ground support for noise and vibration absorption
PAW-GRDSTD40	Outdoor elevation platform 400x900x400 mm
CZ-CENSC1	Econavi energy saving sensor



SEER: For S-5010PK4E + U-50PZ3E5. SCOP: For S-5010PK4E + U-60PZ3E5A. INTERNET CONTROL: Optional.

Rating conditions: Cooling indoor 27 °C DB / 19 °C WB. Cooling outdoor 35 °C DB / 24 °C WB. Heating indoor 20 °C DB. Heating outdoor 7 °C DB / 6 °C WB. (DB: Dry Bulb; WB: Wet Bulb). Specifications subject to change without notice. For detailed information about ErP / Energy Labelling, please visit our websites www.aircon.panasonic.eu or www.ptc.panasonic.eu.

PACi NX Series Elite and Standard 4 way 60x60 cassette - PY3 - R32

- From 2,5 to 6,0 kW (4 capacity sizes)
- Maximum SEER: 7,3 A++ / SCOP: 4,7 A++*
- Built-in drain pump
- DC drain pump and float switch to reduce the noise
- nanoe™ X (Generator Mark 2: 9,6 trillion hydroxyl radicals/sec) as standard for better indoor air quality

* For Elite 3,6 kW model.



Elite			Single phase		
			3,6 kW	5,0 kW	6,0 kW
Kit			KIT-36PY3ZH5	KIT-50PY3ZH5	KIT-60PY3ZH5
Remote controller			CZ-RTC5B	CZ-RTC5B	CZ-RTC5B
Cooling capacity	Nominal (Min - Max)	kW	3,6(1,2 - 4,0)	5,0(1,2 - 5,6)	6,0(1,2 - 6,5)
EER ¹⁾	Nominal (Min - Max)	W/W	4,50(4,04 - 5,45)	3,76(3,41 - 5,45)	3,43(2,77 - 5,45)
SEER²⁾			7,3 A++	7,0 A++	6,7 A++
Pdesign		kW	3,6	5,0	6,0
Input power	Nominal (Min - Max)	kW	0,80(0,22 - 0,99)	1,33(0,22 - 1,64)	1,75(0,20 - 2,35)
Annual energy consumption ³⁾		kWh/a	400	685	875
Heating capacity	Nominal (Min - Max)	kW	4,0(1,2 - 5,0)	5,6(1,2 - 6,5)	7,0(1,2 - 7,5)
Heating capacity at -15 °C ⁴⁾	Max	kW	3,2	4,1	4,8
COP ¹⁾	Nominal (Min - Max)	W/W	4,12(3,45 - 5,45)	3,37(2,95 - 5,45)	3,35(3,38 - 5,45)
SCOP²⁾			4,7 A++	4,6 A++	4,3 A+
Pdesign at -10 °C		kW	3,6	4,5	4,6
Input power	Nominal (Min - Max)	kW	0,97(0,22 - 1,45)	1,66(0,22 - 2,20)	2,09(0,22 - 2,22)
Annual energy consumption ³⁾		kWh/a	1073	1370	1495
Indoor unit			S-36PY3E	S-50PY3E	S-60PY3E
Air flow	Hi / Med / Lo	m ³ /min	9,5/7,5/6,0	12,0/9,5/6,5	14,0/10,5/8,0
Moisture removal volume		L/h	1,5	2,5	2,8
Sound pressure ⁵⁾	Hi / Med / Lo	dB(A)	34/30/25	39/34/27	43/37/31
Sound power	Hi / Med / Lo	dB(A)	49/45/40	54/49/42	58/52/46
Dimension	Indoor (H x W x D)	mm	243 x 575 x 575	243 x 575 x 575	243 x 575 x 575
	Panel (H x W x D)	mm	30 x 625 x 625	30 x 625 x 625	30 x 625 x 625
Net weight	Indoor / Panel	kg	15/2,8	15/2,8	15/2,8
nanoe X Generator			Mark 2	Mark 2	Mark 2
Outdoor unit			U-36PZH3E5	U-50PZH3E5	U-60PZH3E5
Power supply		V	220 - 230 - 240	220 - 230 - 240	220 - 230 - 240
Current	Cool	A	3,95 - 3,60 - 3,60	5,30 - 5,00 - 5,75	8,20 - 7,85 - 7,60
	Heat	A	4,75 - 4,55 - 4,35	7,85 - 7,50 - 7,20	9,70 - 9,25 - 8,90
Air flow	Cool / Heat	m ³ /min	34,1/36,4	42,0/42,0	42,0/42,0
Sound pressure	Cool / Heat (Hi)	dB(A)	43/44	46/48	47/50
Sound power	Cool / Heat (Hi)	dB(A)	62/64	64/67	65/69
Dimension	H x W x D	mm	695 x 875 x 320	695 x 875 x 320	695 x 875 x 320
Net weight		kg	42	42	43
Piping diameter	Liquid	Inch (mm)	1/4 (6,35)	1/4 (6,35)	1/4 (6,35) ⁶⁾
	Gas	Inch (mm)	1/2(12,70)	1/2(12,70)	1/2(12,70) ⁷⁾
Pipe length range		m	3 - 40	3 - 40	3 - 40
Elevation difference (in / out) ⁸⁾		m	15/30	15/30	15/30
Pre-charged pipe length		m	30	30	30
Additional gas amount		g/m	15	15	15
Refrigerant (R32) / CO ₂ Eq.		kg / T	1,13/0,76	1,13/0,76	1,15/0,78
Operating range	Cool Min ~ Max	°C	-15 ~ +46	-15 ~ +46	-15 ~ +46
	Heat Min ~ Max	°C	-20 ~ +24	-20 ~ +24	-20 ~ +24

Compact and stylish design

- Required ceiling depth of only 250 mm
- Exposed area is only 30 mm

Individual flap control

Better control of the air flow with 4 motors, providing individual flap control. Perfect air distribution without direct air flow, to reduce the feeling of cold drafts.

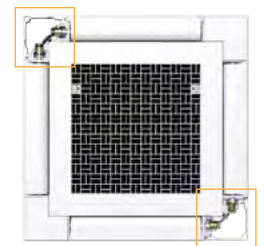

SEER and SCOP: For S-36PY3E + U-36PZH3E5. ECONAVI and INTERNET CONTROL: Optional.

CZ-RTC5B

Panel.
CZ-KPY4

COMPATIBLE WITH ALL PANASONIC CONNECTIVITY SOLUTIONS. FOR DETAILED INFORMATION GO TO THE CONTROL SYSTEMS SECTION

Optional:

CONEX wired
remote
controller,
white.
CZ-RTC6W/
BL/BLW2CONEX wired
remote
controller,
black.
CZ-RTC6/BL/
BLW2Infrared
remote
controller.
CZ-RWS3 +
CZ-RWRY3Econavi
sensor.
CZ-CENS1

Standard

Single phase

			2,5 kW	3,6 kW	5,0 kW	6,0 kW
Kit			KIT-25PY3Z5	KIT-36PY3Z5	KIT-50PY3Z5	KIT-60PY3Z5
Remote controller			CZ-RTC5B	CZ-RTC5B	CZ-RTC5B	CZ-RTC5B
Cooling capacity	Nominal (Min - Max)	kW	2,5(1,5 - 3,9)	3,6(1,5 - 4,0)	5,0(1,5 - 5,6)	6,0(2,0 - 7,0)
EER ¹⁾	Nominal (Min - Max)	W/W	4,46(3,55 - 5,88)	3,96(3,57 - 5,88)	3,50(3,03 - 6,25)	3,39(2,77 - 6,90)
SEER ²⁾			6,5 A++	6,7 A++	7,3 A++	6,8 A++
Pdesign		kW	2,5	3,6	5,0	6,0
Input power	Nominal (Min - Max)	kW	0,56(0,26 - 1,10)	0,91(0,26 - 1,12)	1,43(0,24 - 1,85)	1,77(0,29 - 2,53)
Annual energy consumption ³⁾		kWh/a	134	188	238	3,05
Heating capacity	Nominal (Min - Max)	kW	3,2(1,5 - 4,6)	3,6(1,5 - 4,6)	5,0(1,5 - 6,4)	6,0(1,8 - 7,0)
Heating capacity at -15 °C ⁴⁾	Max	kW	2,6	2,6	3,7	4,7
COP ¹⁾	Nominal (Min - Max)	W/W	4,44(3,41 - 6,52)	4,29(3,38 - 6,52)	3,94(2,91 - 7,50)	3,61(2,86 - 7,60)
SCOP ²⁾			4,6 A++	4,3 A+	4,4 A+	4,2 A+
Pdesign at -10 °C		kW	2,8	2,8	4,0	4,6
Input power	Nominal (Min - Max)	kW	0,72(0,23 - 1,35)	0,84(0,23 - 1,36)	1,27(0,20 - 2,20)	1,66(0,24 - 2,45)
Annual energy consumption ³⁾		kWh/a	850	912	1264	1500
Indoor unit			S-25PY3E	S-36PY3E	S-50PY3E	S-60PY3E
Air flow	Hi / Med / Lo	m ³ /min	8,5/7,0/6,0	9,5/7,0/6,0	12,0/9,5/6,5	14,0/10,5/8,0
Moisture removal volume		L/h	0,7	1,5	2,3	2,8
Sound pressure ⁵⁾	Hi / Med / Lo	dB(A)	31/28/25	34/30/25	39/34/27	43/37/31
Sound power	Hi / Med / Lo	dB(A)	46/43/40	49/45/40	54/49/42	58/52/46
Dimension	Indoor (HxWxD)	mm	243x575x575	243x575x575	243x575x575	243x575x575
	Panel (HxWxD)	mm	30x625x625	30x625x625	30x625x625	30x625x625
Net weight	Indoor / Panel	kg	15/2,8	15/2,8	15/2,8	15/2,8
nanoe X Generator			Mark 2	Mark 2	Mark 2	Mark 2
Outdoor unit			U-25PZ3E5	U-36PZ3E5	U-50PZ3E5	U-60PZ3E5A
Power supply		V	220 - 230 - 240	220 - 230 - 240	220 - 230 - 240	220 - 230 - 240
Current	Cool	A	2,65 - 2,55 - 2,45	4,20 - 4,05 - 3,85	6,65 - 6,35 - 6,10	8,20 - 7,85 - 7,55
	Heat	A	3,40 - 3,25 - 3,10	3,95 - 3,75 - 3,60	5,695 - 5,70 - 5,45	7,70 - 7,35 - 7,05
Air flow	Cool / Heat	m ³ /min	33,6/34,0	32,6/34,0	32,7/31,9	42,6/41,5
Sound pressure	Cool / Heat (Hi)	dB(A)	46/47	46/47	46/48	47/48
Sound power	Cool / Heat (Hi)	dB(A)	64/66	64/66	64/64	64/65
Dimension	HxWxD	mm	619x824x299	619x824x299	619x824x299	695x875x320
Net weight		kg	32	32	35	46
Piping diameter	Liquid	Inch (mm)	1/4 (6,35)	1/4 (6,35)	1/4 (6,35)	1/4 (6,35) ⁶⁾
	Gas	Inch (mm)	1/2(12,70)	1/2(12,70)	1/2(12,70)	1/2(12,70) ⁶⁾
Pipe length range		m	3 - 15	3 - 15	3 - 20	3 - 40
Elevation difference (in / out) ⁸⁾		m	15/15	15/15	15/15	15/30
Pre-charged pipe length		m	7,5	7,5	7,5	30
Additional gas amount		g/m	10	10	15	15
Refrigerant (R32) / CO ₂ Eq.		kg / T	0,87/0,59	0,87/0,59	1,14/0,77	1,15/0,78
Operating range	Cool Min ~ Max	°C	-10 ~ +43	-10 ~ +43	-10 ~ +43	-10 ~ +43
	Heat Min ~ Max	°C	-15 ~ +24	-15 ~ +24	-15 ~ +24	-15 ~ +24

1) EER and COP calculation is based in accordance to EN 14511. 2) For models below 12 kW, the SEER and SCOP is calculated based on values of EU/626/2011. For models above 12 kW, the $\eta_{e,c}$ / $\eta_{e,h}$ values is calculated based on EN 14825. 3) Factory setting. 4) The value is based on the interpolation. 5) The sound pressure of the units shows the value measured of the position 1,5 m below the unit. The sound pressure is measured in accordance with Eurovent 6/C/006-97 specification. 6) Connect the liquid socket tube (Ø6,35-Ø9,52) to the liquid tubing side indoor unit. 7) Connect the gas socket tube (Ø12,70-Ø15,88) to the gas tubing side indoor unit. 8) Outdoor unit located lower / outdoor unit located higher. * Recommended fuse for the indoor 3 A. ** Above values are in the case of nanoe™ X OFF.

Accessories

CZ-RTC6W	CONEX wired remote controller (non-wireless), white
CZ-RTC6WBL	CONEX wired remote controller with Bluetooth®, white
CZ-RTC6WBLW2	CONEX wired remote controller with Wi-Fi and Bluetooth®, white
CZ-RTC6	CONEX wired remote controller (non-wireless), black
CZ-RTC6BL	CONEX wired remote controller with Bluetooth®, black
CZ-RTC6BLW2	CONEX wired remote controller with Wi-Fi and Bluetooth®, black
CZ-RTC5B	Wired remote controller with Econavi function
CZ-RWS3 + CZ-RWRY3	Infrared remote controller and receiver

Accessories

CZ-CAPWFC2	Commercial Wi-Fi Adaptor
PAW-PACR4	Interface to run up to 4 indoor unit groups on backup and alternative run
PAW-WTRAY	Tray for condenser water compatible with outdoor elevation platform
PAW-GRDBSE20	Outdoor base ground support for noise and vibration absorption
PAW-GRDSTD40	Outdoor elevation platform 400x900x400 mm
CZ-CENS1	Econavi energy saving sensor



SEER: For S-50PY3E + U-50PZ3E5. SCOP: For S-25PY3E + U-25PZ3E5. ECONAVI and INTERNET CONTROL: Optional.

Rating conditions: Cooling indoor 27 °C DB / 19 °C WB. Cooling outdoor 35 °C DB / 24 °C WB. Heating indoor 20 °C DB. Heating outdoor 7 °C DB / 6 °C WB. (DB: Dry Bulb; WB: Wet Bulb). Specifications subject to change without notice. For detailed information about ErP / Energy Labelling, please visit our websites www.aircon.panasonic.eu or www.ptc.panasonic.eu.

PACi NX Series Elite 4 way 90x90 cassette - PU3 - R32

4 way 90x90 cassette - PU3.

Powerful turbo fan and intelligent Econavi sensor ensure high energy efficiency, and nanoe™ X, which is equipped as standard, provides an exceptional level of indoor air quality.



			Single phase						
			3,6 kW	5,0 kW	6,0 kW	7,1 kW	10,0 kW	12,5 kW	14,0 kW
Kit			KIT-36PU3ZH5	KIT-50PU3ZH5	KIT-60PU3ZH5	KIT-71PU3ZH45	KIT-100PU3ZH45	KIT-125PU3ZH45	KIT-140PU3ZH45
Remote controller			CZ-RTC5B	CZ-RTC5B	CZ-RTC5B	CZ-RTC5B	CZ-RTC5B	CZ-RTC5B	CZ-RTC5B
Cooling capacity	Nom (Min - Max)	kW	3,6(1,2 - 4,0)	5,0(1,2 - 5,6)	6,0(1,2 - 7,1)	7,1(2,2 - 9,0)	9,5(3,1 - 12,5)	12,5(3,2 - 14,0)	13,4(3,3 - 16,0)
EER ¹⁾	Nom (Min - Max)	W/W	5,45(4,60 - 5,45)	4,31(3,86 - 5,45)	4,05(3,02 - 5,45)	4,06(2,69 - 5,79)	4,42(3,42 - 5,34)	3,80(3,08 - 5,33)	3,60(2,74 - 5,32)
SEER / η_{s,c}²⁾			8,9 A+++	8,6 A+++	8,0 A++	7,7 A++	7,8 A++	304,3%	286,6%
Pdesign		kW	3,6	5,0	6,0	7,1	9,5	12,5	13,4
Input power	Nom (Min - Max)	kW	0,66(0,22 - 0,87)	1,16(0,22 - 1,45)	1,48(0,22 - 2,35)	1,75(0,38 - 3,35)	2,15(0,58 - 3,65)	3,29(0,60 - 4,55)	3,72(0,62 - 5,85)
Annual energy consumption ³⁾		kWh/a	142	203	263	323	426	—	—
Heating capacity	Nom (Min - Max)	kW	4,0(1,2 - 5,0)	5,6(1,2 - 6,5)	7,0(1,2 - 8,0)	8,0(2,0 - 9,0)	11,2(3,1 - 14,0)	14,0(3,2 - 16,0)	16,0(3,3 - 18,0)
Heating capacity at -15 °C ⁴⁾	Max	kW	3,2	4,1	5,1	7,5	11,9	13,4	15,0
COP ¹⁾	Nom (Min - Max)	W/W	5,41(4,55 - 5,45)	4,24(4,19 - 5,45)	4,02(3,40 - 5,45)	4,30(3,16 - 5,56)	5,00(3,64 - 5,54)	4,61(3,37 - 5,52)	4,30(3,27 - 5,50)
SCOP / η_{s,h}²⁾			5,1 A+++	4,9 A++	4,8 A++	4,8 A++	4,9 A++	186,0%	181,2%
Pdesign at -10 °C		kW	3,6	4,5	4,7	5,2	8,0	9,5	10,6
Input power	Nom (Min - Max)	kW	0,74(0,22 - 1,10)	1,32(0,22 - 1,55)	1,74(0,22 - 2,35)	1,86(0,36 - 2,85)	2,24(0,56 - 3,85)	3,04(0,58 - 4,75)	3,72(0,60 - 5,50)
Annual energy consumption ³⁾		kWh/a	988	1286	1371	1517	2286	—	—
Indoor unit			S-3650PU3E	S-3650PU3E	S-6071PU3E	S-6071PU3E	S-1014PU3E	S-1014PU3E	S-1014PU3E
Air flow	Hi / Med / Lo	m ³ /min	14,5/13,0/11,5	16,5/13,5/11,5	21,0/16,0/13,0	22,0/16,0/13,0	36,0/26,0/18,0	37,0/27,0/19,0	38,0/29,0/20,0
Moisture removal volume		L/h	0,7	1,6	1,7	2,5	1,9	4,8	4,9
Sound pressure ⁵⁾	Hi / Med / Lo	dB(A)	30/28/27	32/29/27	36/31/28	37/31/28	45/38/32	46/39/33	47/40/34
Sound power	Hi / Med / Lo	dB(A)	45/43/42	47/44/42	51/46/43	52/46/43	60/53/47	61/54/48	62/55/49
Dimension	Indoor (H x W x D)	mm	256 x 840 x 840	256 x 840 x 840	256 x 840 x 840	256 x 840 x 840	319 x 840 x 840	319 x 840 x 840	319 x 840 x 840
	Panel (H x W x D)	mm	33,5 x 950 x 950	33,5 x 950 x 950	33,5 x 950 x 950	33,5 x 950 x 950	33,5 x 950 x 950	33,5 x 950 x 950	33,5 x 950 x 950
Net weight	Indoor / Panel	kg	19/5	19/5	20/5	20/5	25/5	25/5	25/5
nanoe X Generator			Mark 1	Mark 1	Mark 1	Mark 1	Mark 1	Mark 1	Mark 1
Outdoor unit			U-36PZH3E5	U-50PZH3E5	U-60PZH3E5	U-71PZH4E5	U-100PZH4E5	U-125PZH4E5	U-140PZH4E5
Power supply		V	220 - 230 - 240	220 - 230 - 240	220 - 230 - 240	220 - 230 - 240	220 - 230 - 240	220 - 230 - 240	220 - 230 - 240
Current	Cool	A	3,25 - 3,10 - 3,00	5,50 - 5,25 - 5,05	6,95 - 6,65 - 6,35	8,85 - 8,45 - 8,10	10,06 - 10,02 - 9,75	16,10 - 15,40 - 14,70	18,20 - 17,40 - 16,70
	Heat	A	3,60 - 3,45 - 3,30	6,25 - 6,00 - 5,75	8,05 - 7,70 - 7,40	9,40 - 9,00 - 8,60	10,90 - 10,60 - 10,10	14,90 - 14,20 - 13,60	18,20 - 17,40 - 16,70
Air flow	Cool / Heat	m ³ /min	34,1/36,4	42,0/42,0	42,0/42,0	62,0/66,0	76,0/70,0	86,0/78,0	89,0/83,0
Sound pressure	Cool / Heat (Hi)	dB(A)	43/44	46/48	47/50	48/50	52/52	55/55	56/56
Sound power	Cool / Heat (Hi)	dB(A)	62/64	64/67	65/69	65/67	69/69	73/73	74/74
Dimension	H x W x D	mm	695 x 875 x 320	695 x 875 x 320	695 x 875 x 320	996 x 980 x 370	996 x 980 x 370	996 x 980 x 370	996 x 980 x 370
Net weight		kg	42	42	43	66	84	86	86
Piping diameter	Liquid	Inch (mm)	1/4 (6,35)	1/4 (6,35)	1/4 (6,35) ⁶⁾	3/8 (9,52)	3/8 (9,52)	3/8 (9,52)	3/8 (9,52)
	Gas	Inch (mm)	1/2 (12,70)	1/2 (12,70)	1/2 (12,70) ⁷⁾	5/8 (15,88)	5/8 (15,88)	5/8 (15,88)	5/8 (15,88)
Pipe length range		m	3 - 40	3 - 40	3 - 40	5 - 60	5 - 100	5 - 100	5 - 100
Elevation difference (in / out) ⁸⁾		m	15/30	15/30	15/30	15/30	15/30	15/30	15/30
Pre-charged pipe length		m	30	30	30	30	30	30	30
Additional gas amount		g/m	15	15	15	30	40	40	40
Refrigerant (R32) / CO ₂ Eq.		kg / T	1,13/0,76	1,13/0,76	1,15/0,78	1,95/1,32	2,70/1,82	3,00/2,03	3,00/2,03
Operating range	Cool Min ~ Max	°C	-15 ~ +46	-15 ~ +46	-15 ~ +46	-15 ~ +52	-20 ⁹⁾ ~ +52	-20 ⁹⁾ ~ +52	-20 ⁹⁾ ~ +52
	Heat Min ~ Max	°C	-20 ~ +24	-20 ~ +24	-20 ~ +24	-20 ~ +24	-20 ~ +24	-20 ~ +24	-20 ~ +24

Technical focus

- High performance turbo fan
- Econavi: An optional intelligent sensor to reduce waste of energy
- nanoe™ X (Generator Mark 1: 4,8 trillion hydroxyl radicals/sec) as standard for better indoor air quality, indoor unit internal cleaning with nanoe™ X plus dry operation
- **New** graphite black and white panels providing options to suit a variety of light commercial applications
- Lower noise in low fan operation
- Light weight, easy piping and integrated drain pump for quick installation
- Wired remote control CZ-RTC6WBL and CZ-RTC6BL allows easy system setting via Bluetooth®
- High volume fresh air input with optional air-intake plenum and chamber (CZ-FDU3+CZ-ATU2)

White and graphite black panels available for the 4 way 90x90 cassette.

Standard panel, white (RAL9003).

CZ-KPU3



Econavi panel, white (RAL9003).

CZ-KPU3A

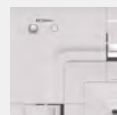

Standard panel, graphite black (RAL9011).

CZ-KPU3B

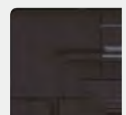

CZ-RTC5B



+ COMPATIBLE WITH ALL PANASONIC CONNECTIVITY SOLUTIONS. FOR DETAILED INFORMATION GO TO THE CONTROL SYSTEMS SECTION

Optional:



CONEX wired remote controller, white.
CZ-RTC6W/BL/BLW2



CONEX wired remote controller, black.
CZ-RTC6/BL/BLW2



Infrared remote controller.
CZ-RWS3 + CZ-RWRU3

Three phase

			7,1 kW	10,0 kW	12,5 kW	14,0 kW
Kit			KIT-71PU3ZH48	KIT-100PU3ZH48	KIT-125PU3ZH48	KIT-140PU3ZH48
Remote controller			CZ-RTC5B	CZ-RTC5B	CZ-RTC5B	CZ-RTC5B
Cooling capacity	Nominal (Min - Max)	kW	7,1 [2,2 - 9,0]	9,5 [3,1 - 12,5]	12,5 [3,2 - 14,0]	13,4 [3,3 - 16,0]
EER ¹⁾	Nominal (Min - Max)	W/W	4,06 [2,69 - 5,79]	4,42 [3,42 - 5,34]	3,80 [3,08 - 5,33]	3,60 [2,74 - 5,32]
SEER / η_{s,c}²⁾			7,7 A++	7,2 A++	303,0%	286,6%
Pdesign		kW	7,1	9,5	12,5	13,4
Input power	Nominal (Min - Max)	kW	1,75 [0,38 - 3,35]	2,15 [0,58 - 3,65]	3,29 [0,60 - 4,55]	3,72 [0,62 - 5,85]
Annual energy consumption ³⁾		kWh/a	323	426	—	—
Heating capacity	Nominal (Min - Max)	kW	8,0 [2,0 - 9,0]	11,2 [3,1 - 14,0]	14,0 [3,2 - 16,0]	16,0 [3,3 - 18,0]
Heating capacity at -15 °C ⁴⁾	Max	kW	7,5	11,9	13,4	15,0
COP ¹⁾	Nominal (Min - Max)	W/W	4,30 [3,16 - 5,56]	5,00 [3,64 - 5,54]	4,61 [3,37 - 5,52]	4,30 [3,27 - 5,50]
SCOP / η_{s,h}²⁾			4,8 A++	4,9 A++	186,0%	181,1%
Pdesign at -10 °C		kW	5,2	8,0	9,5	10,6
Input power	Nominal (Min - Max)	kW	1,86 [0,36 - 2,85]	2,24 [0,56 - 3,85]	3,04 [0,58 - 4,75]	3,72 [0,60 - 5,50]
Annual energy consumption ³⁾		kWh/a	1517	2286	—	—
Indoor unit			S-6071PU3E	S-1014PU3E	S-1014PU3E	S-1014PU3E
Air flow	Hi / Med / Lo	m ³ /min	22,0 / 16,0 / 13,0	36,0 / 26,0 / 18,0	37,0 / 27,0 / 19,0	38,0 / 29,0 / 20,0
Moisture removal volume		L/h	2,5	1,9	4,8	4,9
Sound pressure ⁵⁾	Hi / Med / Lo	dB(A)	37 / 31 / 28	45 / 38 / 32	46 / 39 / 33	47 / 40 / 34
Sound power	Hi / Med / Lo	dB(A)	52 / 46 / 43	60 / 53 / 47	61 / 54 / 48	62 / 55 / 49
Dimension	Indoor (H x W x D)	mm	256 x 840 x 840	319 x 840 x 840	319 x 840 x 840	319 x 840 x 840
	Panel (H x W x D)	mm	33,5 x 950 x 950	33,5 x 950 x 950	33,5 x 950 x 950	33,5 x 950 x 950
Net weight	Indoor / Panel	kg	20 / 5	25 / 5	25 / 5	25 / 5
nanoe X Generator			Mark 1	Mark 1	Mark 1	Mark 1
Outdoor unit			U-71PZH4E8	U-100PZH4E8	U-125PZH4E8	U-140PZH4E8
Power supply		V	380 - 400 - 415	380 - 400 - 415	380 - 400 - 415	380 - 400 - 415
Current	Cool	A	2,95 - 2,80 - 2,70	3,60 - 3,40 - 3,25	5,45 - 5,15 - 5,00	6,15 - 5,85 - 5,65
	Heat	A	3,15 - 3,00 - 2,90	3,75 - 3,55 - 3,40	5,10 - 4,80 - 4,65	6,20 - 5,90 - 5,65
Air flow	Cool / Heat	m ³ /min	62,0 / 66,0	76,0 / 70,0	86,0 / 78,0	89,0 / 83,0
Sound pressure	Cool / Heat (Hi)	dB(A)	48 / 50	52 / 52	55 / 55	56 / 56
Sound power	Cool / Heat (Hi)	dB(A)	65 / 67	69 / 69	73 / 73	74 / 74
Dimension	H x W x D	mm	996 x 980 x 370	996 x 980 x 370	996 x 980 x 370	996 x 980 x 370
Net weight		kg	66	82	84	84
Piping diameter	Liquid	Inch (mm)	3/8 (9,52)	3/8 (9,52)	3/8 (9,52)	3/8 (9,52)
	Gas	Inch (mm)	5/8 (15,88)	5/8 (15,88)	5/8 (15,88)	5/8 (15,88)
Pipe length range		m	5 - 60	5 - 100	5 - 100	5 - 100
Elevation difference (in / out) ⁸⁾		m	15 / 30	15 / 30	15 / 30	15 / 30
Pre-charged pipe length		m	30	30	30	30
Additional gas amount		g/m	30	40	40	40
Refrigerant (R32) / CO ₂ Eq.		kg / T	1,95 / 1,32	2,70 / 1,82	3,00 / 2,03	3,00 / 2,03
Operating range	Cool Min ~ Max	°C	-15 ~ +52	-20 ⁹⁾ ~ +52	-20 ⁹⁾ ~ +52	-20 ⁹⁾ ~ +52
	Heat Min ~ Max	°C	-20 ~ +24	-20 ~ +24	-20 ~ +24	-20 ~ +24

1) EER and COP calculation is based in accordance to EN 14511. 2) For models below 12 kW, the SEER and SCOP is calculated based on values of EU/626/2011. For models above 12 kW, the η_{s,c} / η_{s,h} values is calculated based on EN 14825. 3) Factory setting. 4) The value is based on the interpolation. 5) The sound pressure of the units shows the value measured of the position 1,5 m below the unit. The sound pressure is measured in accordance with Eurovent 6/C/006-97 specification. 6) Connect the liquid socket tube (Ø6,35-Ø9,52) to the liquid tubing side indoor unit. 7) Connect the gas socket tube (Ø12,70-Ø15,88) to the gas tubing side indoor unit. 8) Outdoor unit located lower / outdoor unit located higher. 9) Pipe length up to 30 m. * Recommended fuse for the indoor 3 A. ** Above values are in the case of nanoe™ X OFF.

Accessories

CZ-RTC6W	CONEX wired remote controller (non-wireless), white
CZ-RTC6WBL	CONEX wired remote controller with Bluetooth®, white
CZ-RTC6WBLW2	CONEX wired remote controller with Wi-Fi and Bluetooth®, white
CZ-RTC6	CONEX wired remote controller (non-wireless), black
CZ-RTC6BL	CONEX wired remote controller with Bluetooth®, black
CZ-RTC6BLW2	CONEX wired remote controller with Wi-Fi and Bluetooth®, black
CZ-RTC5B	Wired remote controller with Econavi function
CZ-RWS3 + CZ-RWRU3	Infrared remote controller and receiver
CZ-CAPWFC2	Commercial Wi-Fi Adaptor

Accessories

CZ-KPU3A	Econavi exclusive panel, white (RAL9003)
CZ-KPU3B	NEW Standard panel, graphite black (RAL9011)
PAW-PACR4	Interface to run up to 4 indoor unit groups on backup and alternative run
PAW-WTRAY	Tray for condenser water compatible with outdoor elevation platform
PAW-GRDBSE20	Outdoor base ground support for noise and vibration absorption
PAW-GRDSTD40	Outdoor elevation platform 400 x 900 x 400 mm
CZ-FDU3+CZ-ATU2	Fresh air-intake kit



SEER and SCOP: For S-3650PU3E + U-36PZH3E5. ECONAVI and INTERNET CONTROL: Optional.

Rating conditions: Cooling indoor 27 °C DB / 19 °C WB. Cooling outdoor 35 °C DB / 24 °C WB. Heating indoor 20 °C DB. Heating outdoor 7 °C DB / 6 °C WB. (DB: Dry Bulb; WB: Wet Bulb). Specifications subject to change without notice. For detailed information about ErP / Energy Labelling, please visit our websites www.aircon.panasonic.eu or www.ptc.panasonic.eu.

PACi NX Series Standard 4 way 90x90 cassette - PU3 · R32

4 way 90x90 cassette - PU3.

Powerful turbo fan and intelligent Econavi sensor ensure high energy efficiency, and nanoe™ X, which is equipped as standard, provides an exceptional level of indoor air quality.



			Single phase						
			3,6 kW	5,0 kW	6,0 kW	7,1 kW	10,0 kW	12,5 kW	14,0 kW
Kit			KIT-36PU3Z5	KIT-50PU3Z5	KIT-60PU3Z5	KIT-71PU3Z5	KIT-100PU3Z5	KIT-125PU3Z5	KIT-140PU3Z5
Remote controller			CZ-RTC5B	CZ-RTC5B	CZ-RTC5B	CZ-RTC5B	CZ-RTC5B	CZ-RTC5B	CZ-RTC5B
Cooling capacity	Nom (Min - Max)	kW	3,6(1,5 - 4,0)	5,0(1,5 - 5,6)	6,0(2,0 - 7,1)	7,1(2,6 - 7,7)	10,0(3,0 - 11,5)	12,5(3,2 - 13,5)	14,0(3,3 - 15,0)
EER ¹⁾	Nom (Min - Max)	W/W	4,34(5,88-3,81)	3,91(6,25-3,20)	3,73(6,90-3,01)	3,27(5,00-2,77)	3,82(2,88 - 5,36)	3,58(2,81 - 5,33)	3,23(2,73 - 5,32)
SEER / η_{s,c}²⁾			8,1 A++	8,0 A++	7,8 A++	6,8 A++	6,8 A++	267,0%	257,0%
Pdesign		kW	3,6	5,0	6,0	7,1	10,0	12,5	14,0
Input power	Nom (Min - Max)	kW	0,83(0,25-1,05)	1,28(0,24-1,75)	1,61(0,29-2,36)	2,17(0,52-2,78)	2,62(0,56 - 4,00)	3,49(0,60 - 4,80)	4,34(0,62 - 5,50)
Annual energy consumption ³⁾		kWh/a	156	219	269	365	515	—	—
Heating capacity	Nom (Min - Max)	kW	3,6(1,5 - 4,6)	5,0(1,5 - 6,4)	6,0(1,8 - 7,0)	7,1(2,1 - 8,1)	10,0(3,0 - 14,0)	12,5(3,3 - 15,0)	14,0(3,4 - 16,0)
Heating capacity at -15 °C ⁴⁾	Max	kW	2,7	3,7	4,7	4,8	8,2	10,5	10,8
COP ¹⁾	Nom (Min - Max)	W/W	5,07(4,32 - 6,52)	4,63(3,48 - 7,50)	4,48(3,18 - 7,50)	4,23(3,38 - 6,36)	4,93(3,59 - 5,36)	4,43(3,57 - 5,50)	4,18(3,33 - 5,48)
SCOP / η_{s,h}²⁾			4,8 A++	4,7 A++	4,9 A++	4,6 A++	4,4 A+	157,0%	152,2%
Pdesign at -10 °C		kW	2,8	4,0	4,6	5,2	10,0	12,5	14,0 (at -7 °C)
Input power	Nom (Min - Max)	kW	0,71(0,23-1,06)	1,08(0,20-1,84)	1,34(0,24-2,20)	1,68(0,33-2,40)	2,03(0,56 - 3,90)	2,82(0,60 - 4,20)	3,35(0,62 - 4,80)
Annual energy consumption ³⁾		kWh/a	817	1191	1314	1583	3182	—	—
Indoor unit			S-3650PU3E	S-3650PU3E	S-6071PU3E	S-6071PU3E	S-1014PU3E	S-1014PU3E	S-1014PU3E
Air flow	Hi / Med / Lo	m ³ /min	14,5/13,0/11,5	16,5/13,5/11,5	21,0/16,0/13,0	22,0/16,0/13,0	36,0/26,0/18,0	37,0/27,0/19,0	38,0/29,0/20,0
Moisture removal volume		L/h	0,7	1,6	1,7	2,5	2,7	4,8	6,0
Sound pressure ⁵⁾	Hi / Med / Lo	dB(A)	30/28/27	32/29/27	36/31/28	37/31/28	45/38/32	46/39/33	47/40/34
Sound power	Hi / Med / Lo	dB(A)	45/43/42	47/44/42	51/46/43	52/46/43	60/53/47	61/54/48	62/55/49
Dimension	Indoor (H x W x D)	mm	256 x 840 x 840	256 x 840 x 840	256 x 840 x 840	256 x 840 x 840	319 x 840 x 840	319 x 840 x 840	319 x 840 x 840
	Panel (H x W x D)	mm	33,5 x 950 x 950	33,5 x 950 x 950	33,5 x 950 x 950	33,5 x 950 x 950	33,5 x 950 x 950	33,5 x 950 x 950	33,5 x 950 x 950
Net weight	Indoor / Panel	kg	19/5	19/5	20/5	20/5	25/5	25/5	25/5
nanoe X Generator			Mark 1	Mark 1	Mark 1	Mark 1	Mark 1	Mark 1	Mark 1
Outdoor unit			U-36PZ3E5	U-50PZ3E5	U-60PZ3E5A	U-71PZ3E5A	U-100PZ3E5	U-125PZ3E5	U-140PZ3E5
Power supply		V	220 - 230 - 240	220 - 230 - 240	220 - 230 - 240	220 - 230 - 240	220 - 230 - 240	220 - 230 - 240	220 - 230 - 240
Current	Cool	A	3,85 - 3,70 - 3,55	5,95 - 5,70 - 5,45	7,45 - 7,15 - 6,85	10,00 - 9,65 - 9,25	13,10 - 12,50 - 12,00	16,90 - 16,10 - 15,40	21,00 - 20,00 - 19,20
	Heat	A	3,35 - 3,20 - 3,05	5,05 - 4,85 - 4,65	6,20 - 5,95 - 5,70	7,80 - 7,45 - 7,15	10,10 - 9,70 - 9,30	13,60 - 13,00 - 12,50	16,20 - 15,50 - 14,80
Air flow	Cool / Heat	m ³ /min	33,6/34,0	32,7/31,9	42,6/41,5	44,7/45,9	73,0/73,0	82,0/80,0	84,0/82,0
Sound pressure	Cool / Heat (Hi)	dB(A)	46/47	46/46	47/48	48/49	52/52	55/55	56/56
Sound power	Cool / Heat (Hi)	dB(A)	64/66	64/64	64/65	66/68	70/70	73/73	74/74
Dimension	H x W x D	mm	619 x 824 x 299	619 x 824 x 299	695 x 875 x 320	695 x 875 x 320	996 x 980 x 370	996 x 980 x 370	996 x 980 x 370
Net weight		kg	32	35	42	50	83	87	87
Piping diameter	Liquid	Inch (mm)	1/4 (6,35)	1/4 (6,35)	1/4 (6,35) ⁶⁾	1/4 (6,35) ⁶⁾	3/8 (9,52)	3/8 (9,52)	3/8 (9,52)
	Gas	Inch (mm)	1/2 (12,70)	1/2 (12,70)	1/2 (12,70) ⁷⁾	5/8 (15,88)	5/8 (15,88)	5/8 (15,88)	5/8 (15,88)
Pipe length range		m	3 - 15	3 - 20	3 - 40	3 - 40	5 - 50	5 - 50	5 - 50
Elevation difference (in / out) ⁸⁾		m	15/15	15/15	15/30	20/30	15/30	15/30	15/30
Pre-charged pipe length		m	7,5	7,5	30	30	30	30	30
Additional gas amount		g/m	10	15	15	17	45	45	45
Refrigerant (R32) / CO ₂ Eq.		kg / T	0,87/0,59	1,14/0,77	1,15/0,78	1,32/0,89	2,40/1,62	2,80/1,89	2,80/1,89
Operating range	Cool Min ~ Max	°C	-10 ~ +43	-10 ~ +43	-10 ~ +43	-10 ~ +43	-10 ~ +43	-10 ~ +43	-10 ~ +43
	Heat Min ~ Max	°C	-15 ~ +24	-15 ~ +24	-15 ~ +24	-15 ~ +24	-15 ~ +24	-15 ~ +24	-15 ~ +24

Technical focus

- High performance turbo fan
- Econavi: An optional intelligent sensor to reduce waste of energy
- nanoe™ X (Generator Mark 1: 4,8 trillion hydroxyl radicals/sec) as standard for better indoor air quality, indoor unit internal cleaning with nanoe™ X plus dry operation
- **New** graphite black and white panels providing options to suit a variety of light commercial applications
- Lower noise in low fan operation
- Light weight, easy piping and integrated drain pump for quick installation
- Wired remote control CZ-RTC6WBL and CZ-RTC6BL allows easy system setting via Bluetooth®
- High volume fresh air input with optional air-intake plenum and chamber (CZ-FDU3+CZ-ATU2)

White and graphite black panels available for the 4 way 90x90 cassette.

Standard panel, white (RAL9003).

CZ-KPU3



Econavi panel, white (RAL9003).

CZ-KPU3A

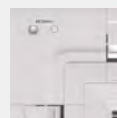

Standard panel, graphite black (RAL9011).

CZ-KPU3B

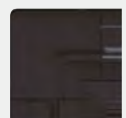

CZ-RTC5B



COMPATIBLE WITH ALL PANASONIC CONNECTIVITY SOLUTIONS. FOR DETAILED INFORMATION GO TO THE CONTROL SYSTEMS SECTION

Optional:



CONEX wired remote controller, white. CZ-RTC6W/BL/BLW2



CONEX wired remote controller, black. CZ-RTC6/BL/BLW2



Infrared remote controller. CZ-RWS3 + CZ-RWRU3

			Three phase		
			10,0 kW	12,5 kW	14,0 kW
Kit			KIT-100PU3Z8	KIT-125PU3Z8	KIT-140PU3Z8
Remote controller			CZ-RTC5B	CZ-RTC5B	CZ-RTC5B
Cooling capacity	Nominal (Min - Max)	kW	10,0 (3,0 - 11,5)	12,5 (3,2 - 13,5)	14,0 (3,3 - 15,0)
EER ¹⁾	Nominal (Min - Max)	W/W	3,82 (2,88 - 5,36)	3,58 (2,81 - 5,33)	3,23 (2,73 - 5,32)
SEER / η _{s,c} ²⁾			6,7 A++	265,8%	256,2%
Pdesign		kW	10,0	12,5	14,0
Input power	Nominal (Min - Max)	kW	2,62 (0,56 - 4,00)	3,49 (0,60 - 4,80)	4,34 (0,62 - 5,50)
Annual energy consumption ³⁾		kWh/a	521	—	—
Heating capacity	Nominal (Min - Max)	kW	10,0 (3,0 - 14,0)	12,5 (3,3 - 15,0)	14,0 (3,4 - 16,0)
Heating capacity at -15 °C ⁴⁾	Max	kW	8,2	10,5	10,8
COP ¹⁾	Nominal (Min - Max)	W/W	4,93 (3,59 - 5,36)	4,43 (3,57 - 5,50)	4,18 (3,33 - 5,48)
SCOP / η _{s,h} ²⁾			4,4 A+	157,0%	152,2%
Pdesign at -10 °C		kW	10,0	12,5	14,0 (at -7 °C)
Input power	Nominal (Min - Max)	kW	2,03 (0,56 - 3,90)	2,82 (0,60 - 4,20)	3,35 (0,62 - 4,80)
Annual energy consumption ³⁾		kWh/a	3182	—	—
Indoor unit			S-1014PU3E	S-1014PU3E	S-1014PU3E
Air flow	Hi / Med / Lo	m ³ /min	36,0/26,0/18,0	37,0/27,0/19,0	38,0/29,0/20,0
Moisture removal volume		L/h	2,7	4,8	6,0
Sound pressure ⁵⁾	Hi / Med / Lo	dB(A)	45/38/32	46/39/33	47/40/34
Sound power	Hi / Med / Lo	dB(A)	60/53/47	61/54/48	62/55/49
Dimension	Indoor (HxWxD)	mm	319 x 840 x 840	319 x 840 x 840	319 x 840 x 840
	Panel (HxWxD)	mm	33,5 x 950 x 950	33,5 x 950 x 950	33,5 x 950 x 950
Net weight	Indoor / Panel	kg	25/5	25/5	25/5
nanoe X Generator			Mark 1	Mark 1	Mark 1
Outdoor unit			U-100PZ3E8	U-125PZ3E8	U-140PZ3E8
Power supply		V	380 - 400 - 415	380 - 400 - 415	380 - 400 - 415
Current	Cool	A	4,35 - 4,15 - 4,00	5,65 - 5,35 - 5,15	7,00 - 6,65 - 6,40
	Heat	A	3,40 - 3,20 - 3,10	4,55 - 4,35 - 4,15	5,40 - 5,15 - 4,95
Air flow	Cool / Heat	m ³ /min	73,0/73,0	82,0/80,0	84,0/82,0
Sound pressure	Cool / Heat (Hi)	dB(A)	52/52	55/55	56/56
Sound power	Cool / Heat (Hi)	dB(A)	70/70	73/73	74/74
Dimension	HxWxD	mm	996 x 980 x 370	996 x 980 x 370	996 x 980 x 370
Net weight		kg	83	87	87
Piping diameter	Liquid	Inch (mm)	3/8 (9,52)	3/8 (9,52)	3/8 (9,52)
	Gas	Inch (mm)	5/8 (15,88)	5/8 (15,88)	5/8 (15,88)
Pipe length range		m	5 - 50	5 - 50	5 - 50
Elevation difference (in / out) ⁸⁾		m	15/30	15/30	15/30
Pre-charged pipe length		m	30	30	30
Additional gas amount		g/m	45	45	45
Refrigerant (R32) / CO ₂ Eq.		kg / T	2,40/1,62	2,80/1,89	2,80/1,89
Operating range	Cool Min ~ Max	°C	-10 ~ +43	-10 ~ +43	-10 ~ +43
	Heat Min ~ Max	°C	-15 ~ +24	-15 ~ +24	-15 ~ +24

1) EER and COP calculation is based in accordance to EN 14511. 2) For models below 12 kW, the SEER and SCOP is calculated based on values of EU/626/2011. For models above 12 kW, the η_{s,c} / η_{s,h} values is calculated based on EN 14825. 3) Factory setting. 4) The value is based on the interpolation. 5) The sound pressure of the units shows the value measured of the position 1,5 m below the unit. The sound pressure is measured in accordance with Eurovent 6/C/006-97 specification. 6) Connect the liquid socket tube (Ø6,35-Ø9,52) to the liquid tubing side indoor unit. 7) Connect the gas socket tube (Ø12,70-Ø15,88) to the gas tubing side indoor unit. 8) Outdoor unit located lower / outdoor unit located higher. * Recommended fuse for the indoor 3 A. ** Above values are in the case of nanoe™ X OFF.

Accessories

CZ-RTC6W	CONEX wired remote controller (non-wireless), white
CZ-RTC6WBL	CONEX wired remote controller with Bluetooth®, white
CZ-RTC6WBLW2	CONEX wired remote controller with Wi-Fi and Bluetooth®, white
CZ-RTC6	CONEX wired remote controller (non-wireless), black
CZ-RTC6BL	CONEX wired remote controller with Bluetooth®, black
CZ-RTC6BLW2	CONEX wired remote controller with Wi-Fi and Bluetooth®, black
CZ-RTC5B	Wired remote controller with Econavi function
CZ-RWS3 + CZ-RWRU3	Infrared remote controller and receiver
CZ-CAPWFC2	Commercial Wi-Fi Adaptor

Accessories

CZ-KPU3A	Econavi exclusive panel, white (RAL9003)
CZ-KPU3B	NEW Standard panel, graphite black (RAL9011)
PAW-PACR4	Interface to run up to 4 indoor unit groups on backup and alternative run
PAW-WTRAY	Tray for condenser water compatible with outdoor elevation platform
PAW-GRDBSE20	Outdoor base ground support for noise and vibration absorption
PAW-GRDSTD40	Outdoor elevation platform 400 x 900 x 400 mm
CZ-FDU3+CZ-ATU2	Fresh air-intake kit



SEER: For S-3650PU3E + U-36PZ3E5. SCOP: For S-6071PU3E + U-60PZ3E5A. ECONAVI and INTERNET CONTROL: Optional.

Rating conditions: Cooling indoor 27 °C DB / 19 °C WB. Cooling outdoor 35 °C DB / 24 °C WB. Heating indoor 20 °C DB. Heating outdoor 7 °C DB / 6 °C WB. (DB: Dry Bulb; WB: Wet Bulb). Specifications subject to change without notice. For detailed information about ErP / Energy Labelling, please visit our websites www.aircon.panasonic.eu or www.ptc.panasonic.eu.

PACi NX Series Elite ceiling - PT3 · R32

Ceiling mounted units provide large and wide air distribution which is ideal for large rooms.

The height and depth of all capacities are the same for unified appearance in mixed installations.



			Single phase							
			3,6 kW	5,0 kW	6,0 kW	7,1 kW	10,0 kW	12,5 kW	14,0 kW	
Kit			KIT-36PT3ZH5	KIT-50PT3ZH5	KIT-60PT3ZH5	KIT-71PT3ZH45	KIT-100PT3ZH45	KIT-125PT3ZH45	KIT-140PT3ZH45	
Remote controller			CZ-RTC5B	CZ-RTC5B	CZ-RTC5B	CZ-RTC5B	CZ-RTC5B	CZ-RTC5B	CZ-RTC5B	
Cooling capacity	Nom (Min - Max)	kW	3,5(1,2 - 4,0)	5,0(1,2 - 5,6)	6,0(1,2 - 7,1)	6,8(2,2 - 9,0)	9,5(3,1 - 12,5)	12,1(3,2 - 14,0)	13,4(3,3 - 16,0)	
EER ¹⁾	Nom (Min - Max)	W/W	4,86(4,55 - 5,45)	4,03(3,57 - 5,45)	3,82(3,02 - 5,45)	3,91(2,69 - 5,79)	4,06(3,29 - 5,34)	3,46(3,01 - 5,33)	3,21(2,67 - 5,32)	
SEER / η _{s,c} ²⁾			7,7 A++	7,4 A++	7,5 A++	7,3 A++	7,3 A++	278,4%	263,3%	
Pdesign		kW	3,5	5,0	6,0	6,8	9,5	12,1	13,4	
Input power	Nom (Min - Max)	kW	0,72(0,22 - 0,88)	1,24(0,22 - 1,57)	1,57(0,22 - 2,35)	1,74(0,38 - 3,35)	2,34(0,58 - 3,80)	3,50(0,60 - 4,65)	4,17(0,62 - 6,00)	
Annual energy consumption ³⁾		kWh/a	160	237	280	326	456	—	—	
Heating capacity	Nom (Min - Max)	kW	4,0(1,2 - 5,0)	5,6(1,2 - 6,5)	7,0(1,2 - 8,0)	8,0(2,0 - 9,0)	11,2(3,1 - 14,0)	14,0(3,2 - 16,0)	16,0(3,3 - 18,0)	
Heating capacity at -15 °C ⁴⁾	Max	kW	3,2	4,1	5,1	7,5	11,9	13,4	15,0	
COP ¹⁾	Nom (Min - Max)	W/W	5,00(4,17 - 5,45)	4,03(3,94 - 5,45)	4,14(3,40 - 5,45)	3,96(3,16 - 5,56)	4,00(3,54 - 5,54)	3,78(3,20 - 5,52)	3,38(3,10 - 5,50)	
SCOP / η _{s,h} ²⁾			4,9 A++	4,8 A++	4,8 A++	4,7 A++	4,5 A+	175,6%	169,3%	
Pdesign at -10 °C		kW	3,1	4,0	4,6	4,7	7,8	9,5	10,2	
Input power	Nom (Min - Max)	kW	0,80(0,22 - 1,20)	1,39(0,22 - 1,65)	1,69(0,22 - 2,35)	2,02(0,36 - 2,85)	2,80(0,56 - 3,95)	3,70(0,58 - 5,00)	4,74(0,60 - 5,80)	
Annual energy consumption ³⁾		kWh/a	886	1167	1342	1400	2426	—	—	
Indoor unit			S-3650PT3E	S-3650PT3E	S-6071PT3E	S-6071PT3E	S-1014PT3E	S-1014PT3E	S-1014PT3E	
Air flow	Hi / Med / Lo	m ³ /min	14,0/12,0/10,5	15,0/12,5/10,5	20,0/17,0/14,5	21,0/18,0/15,5	30,0/25,0/23,0	34,0/28,0/24,0	35,0/29,0/25,0	
Moisture removal volume		L/h	0,8	2,0	2,1	2,7	3,6	5,4	6,4	
Sound pressure ⁵⁾	Hi / Med / Lo	dB(A)	36/32/28	37/33/28	38/34/29	39/35/30	42/37/34	46/40/35	47/41/36	
Sound power	Hi / Med / Lo	dB(A)	54/50/46	55/51/46	56/52/47	57/53/48	60/55/52	64/58/53	65/59/54	
Dimension	H x W x D	mm	235 x 960 x 690	235 x 960 x 690	235 x 1275 x 690	235 x 1275 x 690	235 x 1590 x 690	235 x 1590 x 690	235 x 1590 x 690	
Net weight		kg	26	26	34	34	40	40	40	
nanoe X Generator			Mark 2	Mark 2	Mark 2	Mark 2	Mark 2	Mark 2	Mark 2	
Outdoor unit			U-36PZH3E5	U-50PZH3E5	U-60PZH3E5	U-71PZH4E5	U-100PZH4E5	U-125PZH4E5	U-140PZH4E5	
Power supply		V	220 - 230 - 240	220 - 230 - 240	220 - 230 - 240	220 - 230 - 240	220 - 230 - 240	220 - 230 - 240	220 - 230 - 240	
Current	Cool	A	3,55 - 3,40 - 3,25	5,85 - 5,60 - 5,40	7,35 - 7,05 - 6,75	8,80 - 8,40 - 8,05	11,60 - 11,10 - 10,60	17,10 - 16,40 - 15,70	20,40 - 19,50 - 18,70	
	Heat	A	3,90 - 3,75 - 3,60	6,60 - 6,30 - 6,05	7,85 - 7,50 - 7,20	10,20 - 9,75 - 9,35	13,70 - 13,20 - 12,70	18,10 - 17,30 - 16,60	23,20 - 22,20 - 21,20	
Air flow	Cool / Heat	m ³ /min	34,1/36,4	42,0/42,0	42,0/42,0	62,0/66,0	76,0/70,0	86,0/78,0	89,0/83,0	
Sound pressure	Cool / Heat (Hi)	dB(A)	43/44	46/48	47/50	48/50	52/52	55/55	56/56	
Sound power	Cool / Heat (Hi)	dB(A)	62/64	64/67	65/69	65/67	69/69	73/73	74/74	
Dimension	H x W x D	mm	695 x 875 x 320	695 x 875 x 320	695 x 875 x 320	996 x 980 x 370	996 x 980 x 370	996 x 980 x 370	996 x 980 x 370	
Net weight		kg	42	42	43	66	84	86	86	
Piping diameter	Liquid	Inch (mm)	1/4 (6,35)	1/4 (6,35)	1/4 (6,35) ⁶⁾	3/8 (9,52)	3/8 (9,52)	3/8 (9,52)	3/8 (9,52)	
	Gas	Inch (mm)	1/2 (12,70)	1/2 (12,70)	1/2 (12,70) ⁷⁾	5/8 (15,88)	5/8 (15,88)	5/8 (15,88)	5/8 (15,88)	
Pipe length range		m	3 - 40	3 - 40	3 - 40	5 - 60	5 - 100	5 - 100	5 - 100	
Elevation difference (in / out) ⁸⁾		m	15/30	15/30	15/30	15/30	15/30	15/30	15/30	
Pre-charged pipe length		m	30	30	30	30	30	30	30	
Additional gas amount		g/m	15	15	15	30	40	40	40	
Refrigerant (R32) / CO ₂ Eq.		kg / T	1,13/0,76	1,13/0,76	1,15/0,78	1,95/1,32	2,70/1,82	3,00/2,03	3,00/2,03	
Operating range	Cool Min ~ Max	°C	-15 ~ +46	-15 ~ +46	-15 ~ +46	-15 ~ +52	-20 ⁹⁾ ~ +52	-20 ⁹⁾ ~ +52	-20 ⁹⁾ ~ +52	
	Heat Min ~ Max	°C	-20 ~ +24	-20 ~ +24	-20 ~ +24	-20 ~ +24	-20 ~ +24	-20 ~ +24	-20 ~ +24	

Technical focus

- Wide air distribution for large rooms
- Horizontal air flow reaches maximum 9,5 m
- Fresh air connection available on the unit
- Slim design with 235 mm height fits narrow space
- Silent operation
- nanoe™ X (Generator Mark 2: 9,6 trillion hydroxyl radicals/sec) as standard for better indoor air quality
- Wired remote control CZ-RTC6WBL and CZ-RTC6BL allows easy system setting via Bluetooth®
- Twin, Triple and Double-twin split options
- Easy connection and control of external fan or ERV using the connector PAW-FDC on the indoor unit PCB. The external device can be controlled by the remote control of the Panasonic indoor unit

Further comfort improvement with air flow distribution

Horizontal air flow reaches maximum 9,5 m. This is ideal for wide rooms.

The wide air discharge opening expands the air flow to the left and right. The unpleasant feeling caused when the air flow directly hits the human body is prevented by the "Draft prevention position", which changes the swing width, increasing the degree of comfort.

PACi NX Series Standard ceiling - PT3 · R32

Ceiling mounted units provide large and wide air distribution which is ideal for large rooms.

The height and depth of all capacities are the same for unified appearance in mixed installations.



			Single phase							
			3,6 kW	5,0 kW	6,0 kW	7,1 kW	10,0 kW	12,5 kW	14,0 kW	
Kit			KIT-36PT3Z5	KIT-50PT3Z5	KIT-60PT3Z5	KIT-71PT3Z5	KIT-100PT3Z5	KIT-125PT3Z5	KIT-140PT3Z5	
Remote controller			CZ-RTC5B	CZ-RTC5B	CZ-RTC5B	CZ-RTC5B	CZ-RTC5B	CZ-RTC5B	CZ-RTC5B	
Cooling capacity	Nom (Min - Max)	kW	3,5(1,5 - 4,0)	5,0(1,5 - 5,2)	6,0(2,0 - 7,1)	6,8(2,6 - 7,7)	10,0(3,0 - 11,5)	12,5(3,2 - 13,5)	14,0(3,3 - 15,0)	
EER ¹⁾	Nom (Min - Max)	W/W	4,14(3,69 - 5,17)	3,03(2,86 - 5,00)	3,59(2,90 - 6,90)	3,24(2,75 - 4,91)	3,64(2,80 - 5,36)	3,32(2,77 - 5,33)	2,98(2,73 - 5,32)	
SEER / η_{s,c}²⁾			7,2 A++	6,7 A++	7,3 A++	5,9 A+	6,6 A++	241,7%	228,8%	
Pdesign		kW	3,5	5,0	6,0	6,8	10,0	12,5	14,0	
Input power	Nom (Min - Max)	kW	0,85(0,29 - 1,10)	1,65(0,30 - 1,82)	1,67(0,29 - 2,45)	2,10(0,53 - 2,80)	2,75(0,56 - 4,10)	3,76(0,60 - 4,88)	4,70(0,62 - 5,50)	
Annual energy consumption ³⁾		kWh/a	171	262	288	404	531	—	—	
Heating capacity	Nom (Min - Max)	kW	3,5(1,5 - 4,6)	5,0(1,5 - 6,4)	6,0(1,8 - 7,0)	6,8(2,1 - 8,1)	10,0(3,0 - 14,0)	12,5(3,3 - 15,0)	14,0(3,4 - 16,0)	
Heating capacity at -15 °C ⁴⁾	Max	kW	2,7	3,7	4,7	4,8	8,2	10,5	10,8	
COP ¹⁾	Nom (Min - Max)	W/W	4,61(3,51 - 5,70)	3,73(3,12 - 6,25)	4,11(2,92 - 6,67)	4,20(3,06 - 5,68)	4,24(3,30 - 5,36)	3,89(3,41 - 4,52)	3,70(3,08 - 5,48)	
SCOP / η_{s,h}²⁾			4,4 A+	4,1 A+	4,6 A++	4,3 A+	4,2 A+	147,4%	145,3%	
Pdesign at -10 °C		kW	2,8	4,0	4,6	4,7	10,0	12,5	13,6	
Input power	Nom (Min - Max)	kW	0,76(0,26 - 1,31)	1,34(0,24 - 2,05)	1,46(0,27 - 2,40)	1,62(0,37 - 2,65)	2,36(0,56 - 4,00)	3,21(0,73 - 4,40)	3,78(0,62 - 5,20)	
Annual energy consumption ³⁾		kWh/a	891	1365	1399	1529	3331	—	—	
Indoor unit			S-3650PT3E	S-3650PT3E	S-6071PT3E	S-6071PT3E	S-1014PT3E	S-1014PT3E	S-1014PT3E	
Air flow	Hi / Med / Lo	m ³ /min	14,0/12,0/10,5	15,0/12,5/10,5	20,0/17,0/14,5	21,0/18,0/15,5	30,0/25,0/23,0	34,0/28,0/24,0	35,0/29,0/25,0	
Moisture removal volume		L/h	0,8	2,0	2,1	2,7	4,1	5,7	6,9	
Sound pressure ⁵⁾	Hi / Med / Lo	dB(A)	36/32/28	37/33/28	38/34/29	39/35/30	42/37/34	46/40/35	47/41/36	
Sound power	Hi / Med / Lo	dB(A)	54/50/46	55/51/46	56/52/47	57/53/48	60/55/52	64/58/53	65/59/54	
Dimension	H x W x D	mm	235 x 960 x 690	235 x 960 x 690	235 x 1275 x 690	235 x 1275 x 690	235 x 1590 x 690	235 x 1590 x 690	235 x 1590 x 690	
Net weight		kg	26	26	34	34	40	40	40	
nanoe X Generator			Mark 2	Mark 2	Mark 2	Mark 2	Mark 2	Mark 2	Mark 2	
Outdoor unit			U-36PZ3E5	U-50PZ3E5	U-60PZ3E5A	U-71PZ3E5A	U-100PZ3E5	U-125PZ3E5	U-140PZ3E5	
Power supply		V	220 - 230 - 240	220 - 230 - 240	220 - 230 - 240	220 - 230 - 240	220 - 230 - 240	220 - 230 - 240	220 - 230 - 240	
Current	Cool	A	3,90 - 3,75 - 3,60	7,65 - 7,30 - 7,00	7,75 - 7,40 - 7,10	9,75 - 9,30 - 8,95	13,70 - 13,10 - 12,60	18,20 - 17,40 - 16,70	22,70 - 21,70 - 20,80	
	Heat	A	3,55 - 3,40 - 3,25	6,30 - 6,00 - 5,75	6,75 - 6,50 - 6,20	7,50 - 7,20 - 6,90	11,80 - 11,30 - 10,80	15,50 - 14,80 - 14,20	18,30 - 17,50 - 16,80	
Air flow	Cool / Heat	m ³ /min	33,6/34,0	32,7/31,9	42,6/41,5	44,7/45,9	73,0/73,0	82,0/80,0	84,0/82,0	
Sound pressure	Cool / Heat (Hi)	dB(A)	46/47	46/46	47/48	48/49	52/52	55/55	56/56	
Sound power	Cool / Heat (Hi)	dB(A)	64/66	64/64	64/65	66/68	70/70	73/73	74/74	
Dimension	H x W x D	mm	619 x 824 x 299	619 x 824 x 299	695 x 875 x 320	695 x 875 x 320	996 x 980 x 370	996 x 980 x 370	996 x 980 x 370	
Net weight		kg	32	35	42	50	83	87	87	
Piping diameter	Liquid	Inch (mm)	1/4 (6,35)	1/4 (6,35)	1/4 (6,35) ⁶⁾	1/4 (6,35) ⁶⁾	3/8 (9,52)	3/8 (9,52)	3/8 (9,52)	
	Gas	Inch (mm)	1/2 (12,70)	1/2 (12,70)	1/2 (12,70) ⁷⁾	5/8 (15,88)	5/8 (15,88)	5/8 (15,88)	5/8 (15,88)	
Pipe length range		m	3 - 15	3 - 20	3 - 40	3 - 40	5 - 50	5 - 50	5 - 50	
Elevation difference (in / out) ⁸⁾		m	15/15	15/15	15/30	20/30	15/30	15/30	15/30	
Pre-charged pipe length		m	7,5	7,5	30	30	30	30	30	
Additional gas amount		g/m	10	15	15	17	45	45	45	
Refrigerant (R32) / CO ₂ Eq.		kg / T	0,87/0,59	1,14/0,77	1,15/0,78	1,32/0,89	2,40/1,62	2,80/1,89	2,80/1,89	
Operating range	Cool Min ~ Max	°C	-10 ~ +43	-10 ~ +43	-10 ~ +43	-10 ~ +43	-10 ~ +43	-10 ~ +43	-10 ~ +43	
	Heat Min ~ Max	°C	-15 ~ +24	-15 ~ +24	-15 ~ +24	-15 ~ +24	-15 ~ +24	-15 ~ +24	-15 ~ +24	

Technical focus

- Wide air distribution for large rooms
- Horizontal air flow reaches maximum 9,5 m
- Fresh air connection available on the unit
- Slim design with 235 mm height fits narrow space
- Silent operation
- nanoe™ X (Generator Mark 2: 9,6 trillion hydroxyl radicals/sec) as standard for better indoor air quality
- Wired remote control CZ-RTC6WBL and CZ-RTC6BL allows easy system setting via Bluetooth®
- Single and Twin options
- Easy connection and control of external fan or ERV using the connector PAW-FDC on the indoor unit PCB. The external device can be controlled by the remote control of the Panasonic indoor unit

Further comfort improvement with air flow distribution

Horizontal air flow reaches maximum 9,5 m. This is ideal for wide rooms.

The wide air discharge opening expands the air flow to the left and right. The unpleasant feeling caused when the air flow directly hits the human body is prevented by the "Draft prevention position", which changes the swing width, increasing the degree of comfort.

CZ-RTC5B



+ COMPATIBLE WITH ALL PANASONIC CONNECTIVITY SOLUTIONS. FOR DETAILED INFORMATION GO TO THE CONTROL SYSTEMS SECTION

Optional:



CONEX wired remote controller, white. CZ-RTC6W/BL/BLW2



CONEX wired remote controller, black. CZ-RTC6/BL/BLW2



Infrared remote controller. CZ-RWS3 + CZ-RWRT3



Econavi sensor. CZ-CENSC1

			Three phase		
			10,0 kW	12,5 kW	14,0 kW
Kit			KIT-100PT3Z8	KIT-125PT3Z8	KIT-140PT3Z8
Remote controller			CZ-RTC5B	CZ-RTC5B	CZ-RTC5B
Cooling capacity	Nominal (Min - Max)	kW	10,0 (3,0 - 11,5)	12,5 (3,2 - 13,5)	14,0 (3,3 - 15,0)
EER ¹⁾	Nominal (Min - Max)	W/W	3,64 (3,50 - 5,36)	3,32 (2,77 - 5,33)	2,98 (2,73 - 5,32)
SEER / η_{s,c}²⁾			6,5 A++	241,7%	228,8%
Pdesign		kW	10,0	12,5	14,0
Input power	Nominal (Min - Max)	kW	2,75 (0,56 - 4,10)	3,76 (0,60 - 4,88)	4,70 (0,62 - 5,50)
Annual energy consumption ³⁾		kWh/a	537	—	—
Heating capacity	Nominal (Min - Max)	kW	10,0 (3,0 - 14,0)	12,5 (3,3 - 15,0)	14,0 (3,4 - 16,0)
Heating capacity at -15 °C ⁴⁾	Max	kW	8,2	10,5	10,8
COP ¹⁾	Nominal (Min - Max)	W/W	4,24 (3,50 - 5,36)	3,89 (3,41 - 4,52)	3,70 (3,08 - 5,48)
SCOP / η_{s,h}²⁾			4,2 A+	147,4%	145,3%
Pdesign at -10 °C		kW	10,0	12,5	13,6
Input power	Nominal (Min - Max)	kW	2,36 (0,56 - 4,00)	3,21 (0,73 - 4,40)	3,78 (0,62 - 5,20)
Annual energy consumption ³⁾		kWh/a	3331	—	—
Indoor unit			S-1014PT3E	S-1014PT3E	S-1014PT3E
Air flow	Hi / Med / Lo	m ³ /min	30,0/25,0/23,0	34,0/28,0/24,0	35,0/29,0/25,0
Moisture removal volume		L/h	4,1	5,7	6,9
Sound pressure ⁵⁾	Hi / Med / Lo	dB(A)	42/37/34	46/40/35	47/41/36
Sound power	Hi / Med / Lo	dB(A)	60/55/52	64/58/53	65/59/54
Dimension	H x W x D	mm	235 x 1590 x 690	235 x 1590 x 690	235 x 1590 x 690
Net weight		kg	40	40	40
nanoe X Generator			Mark 2	Mark 2	Mark 2
Outdoor unit			U-100PZ3E8	U-125PZ3E8	U-140PZ3E8
Power supply		V	380 - 400 - 415	380 - 400 - 415	380 - 400 - 415
Current	Cool	A	4,60 - 4,35 - 4,20	6,10 - 5,75 - 5,55	7,60 - 7,20 - 6,95
	Heat	A	3,95 - 3,75 - 3,60	5,20 - 4,95 - 4,75	6,10 - 5,80 - 5,60
Air flow	Cool / Heat	m ³ /min	73,0/73,0	82,0/80,0	84,0/82,0
Sound pressure	Cool / Heat (Hi)	dB(A)	52/52	55/55	56/56
Sound power	Cool / Heat (Hi)	dB(A)	70/70	73/73	74/74
Dimension	H x W x D	mm	996 x 980 x 370	996 x 980 x 370	996 x 980 x 370
Net weight		kg	83	87	87
Piping diameter	Liquid	Inch (mm)	3/8 (9,52)	3/8 (9,52)	3/8 (9,52)
	Gas	Inch (mm)	5/8 (15,88)	5/8 (15,88)	5/8 (15,88)
Pipe length range		m	5 - 50	5 - 50	5 - 50
Elevation difference (in / out) ⁶⁾		m	15/30	15/30	15/30
Pre-charged pipe length		m	30	30	30
Additional gas amount		g/m	45	45	45
Refrigerant (R32) / CO ₂ Eq.		kg / T	2,40/1,62	2,8/1,89	2,8/1,89
Operating range	Cool Min ~ Max	°C	-10 ~ +43	-10 ~ +43	-10 ~ +43
	Heat Min ~ Max	°C	-15 ~ +24	-15 ~ +24	-15 ~ +24

1) EER and COP calculation is based in accordance to EN 14511. 2) For models below 12 kW, the SEER and SCOP is calculated based on values of EU/626/2011. For models above 12 kW, the η_{s,c} / η_{s,h} values is calculated based on EN 14825. 3) Factory setting. 4) The value is based on the interpolation. 5) The sound pressure of the units shows the value measured of the position 1 m in front of the main body and 1 m below the unit. The sound pressure is measured in accordance with Eurovent 6/C/006-97 specification. 6) Connect the liquid socket tube (Ø6,35-Ø9,52) to the liquid tubing side indoor unit. 7) Connect the gas socket tube (Ø12,70-Ø15,88) to the gas tubing side indoor unit. 8) Outdoor unit located lower / outdoor unit located higher. * Recommended fuse for the indoor 3 A. ** Above values are in the case of nanoe™ X OFF.

Accessories

CZ-RTC6W	CONEX wired remote controller (non-wireless), white
CZ-RTC6WBL	CONEX wired remote controller with Bluetooth®, white
CZ-RTC6WBLW2	CONEX wired remote controller with Wi-Fi and Bluetooth®, white
CZ-RTC6	CONEX wired remote controller (non-wireless), black
CZ-RTC6BL	CONEX wired remote controller with Bluetooth®, black
CZ-RTC6BLW2	CONEX wired remote controller with Wi-Fi and Bluetooth®, black
CZ-RTC5B	Wired remote controller with Econavi function
CZ-RWS3 + CZ-RWRT3	Infrared remote controller and receiver

Accessories

CZ-CAPWFC2	Commercial Wi-Fi Adaptor
PAW-PACR4	Interface to run up to 4 indoor unit groups on backup and alternative run
PAW-WTRAY	Tray for condenser water compatible with outdoor elevation platform
PAW-GRDBSE20	Outdoor base ground support for noise and vibration absorption
PAW-GRDSTD40	Outdoor elevation platform 400 x 900 x 400 mm
CZ-CENSC1	Econavi energy saving sensor



SEER and SCOP: For S-6071PT3E + U-60PZ3E5A. INTERNET CONTROL: Optional.

Rating conditions: Cooling indoor 27 °C DB / 19 °C WB. Cooling outdoor 35 °C DB / 24 °C WB. Heating indoor 20 °C DB. Heating outdoor 7 °C DB / 6 °C WB. (DB: Dry Bulb; WB: Wet Bulb). Specifications subject to change without notice. For detailed information about ErP / Energy Labelling, please visit our websites www.aircon.panasonic.eu or www.ptc.panasonic.eu.

PACi NX Series Elite adaptive ducted unit - PF3 · R32

Adaptive ducted unit - PF3.

2 installation possibilities (horizontal / vertical) with high ESP 150Pa allows flexible installation.



		Single phase							
		3,6 kW	5,0 kW	6,0 kW	7,1 kW	10,0 kW	12,5 kW	14,0 kW	
Kit		KIT-36PF3ZH5	KIT-50PF3ZH5	KIT-60PF3ZH5	KIT-71PF3ZH45	KIT-100PF3ZH45	KIT-125PF3ZH45	KIT-140PF3ZH45	
Remote controller		CZ-RTC5B	CZ-RTC5B	CZ-RTC5B	CZ-RTC5B	CZ-RTC5B	CZ-RTC5B	CZ-RTC5B	
Cooling capacity	Nom (Min - Max)	kW	3,6(1,2 - 4,0)	5,0(1,2 - 5,6)	5,7(1,2 - 6,3)	6,8(2,2 - 7,8)	9,5(3,1 - 11,4)	12,1(3,2 - 13,6)	13,4(3,3 - 15,3)
EER ¹⁾	Nom (Min - Max)	W/W	4,24(3,57 - 5,45)	3,42(3,11 - 5,45)	3,68(3,15 - 5,45)	3,74(2,41 - 5,64)	4,09(2,82 - 5,08)	3,53(3,00 - 5,00)	3,38(2,59 - 4,18)
SEER / η _{s,c} ²⁾			6,8 A++	6,1 A++	7,1 A++	7,1 A++	7,4 A++	281,7%	275,9%
Pdesign		kW	3,6	5,0	5,7	6,8	9,5	12,1	13,4
Input power	Nom (Min - Max)	kW	0,85(0,22 - 1,12)	1,46(0,22 - 1,80)	1,55(0,22 - 2,00)	1,82(0,39 - 3,24)	3,23(0,61 - 4,04)	3,43(0,64 - 4,54)	3,96(0,79 - 5,90)
Annual energy consumption ³⁾		kWh/a	185	287	281	332	447	—	—
Heating capacity	Nom (Min - Max)	kW	4,0(1,2 - 5,0)	5,6(1,2 - 6,5)	7,0(1,2 - 8,0)	7,5(2,0 - 9,0)	10,8(3,1 - 13,5)	13,5(3,2 - 15,4)	15,5(3,3 - 17,4)
Heating capacity at -15 °C ⁴⁾	Max	kW	3,2	4,1	5,1	7,5	11,5	12,9	14,5
COP ¹⁾	Nom (Min - Max)	W/W	4,17(3,23 - 5,45)	3,61(2,97 - 5,45)	3,74(3,33 - 5,45)	4,03(3,16 - 5,41)	3,88(3,07 - 5,25)	3,46(3,06 - 5,16)	3,33(3,14 - 4,29)
SCOP / η _{s,h} ²⁾			4,5 A+	4,2 A+	4,4 A+	4,7 A++	4,3 A+	165,0%	162,6%
Pdesign at -10 °C		kW	3,6	4,0	4,7	4,7	7,8	9,3	9,5
Input power	Nom (Min - Max)	kW	0,96(0,22 - 1,55)	1,55(0,22 - 2,19)	1,87(0,22 - 2,40)	1,86(0,37 - 2,85)	2,78(0,59 - 4,40)	3,90(0,62 - 5,04)	4,65(0,77 - 5,55)
Annual energy consumption ³⁾		kWh/a	1120	1333	1495	1393	2540	—	—
Indoor unit			S-3650PF3E	S-3650PF3E	S-6071PF3E	S-6071PF3E	S-1014PF3E	S-1014PF3E	S-1014PF3E
External static pressure ⁵⁾	Nom (Min - Max)	Pa	30(10 - 150)	30(10 - 150)	30(10 - 150)	30(10 - 150)	40(10 - 150)	50(10 - 150)	50(10 - 150)
Air flow	Hi / Med / Lo	m ³ /min	14,0/13,0/10,0	16,0/15,0/12,0	21,0/19,0/15,0	21,0/19,0/15,0	20,0/26,0/21,0	34,0/29,0/23,0	36,0/32,0/25,0
Moisture removal volume		L/h	0,9	1,9	1,7	2,7	3,2	4,1	4,9
Sound pressure ⁶⁾	Hi / Med / Lo	dB(A)	30/27/22	34/30/25	30/26/23	30/26/23	33/29/25	35/31/27	39/35/29
Sound power	Hi / Med / Lo	dB(A)	53/50/45	57/53/48	53/49/46	53/49/46	56/52/48	58/54/50	62/58/52
Dimension	HxWxD	mm	250x800x730	250x800x730	250x1000x730	250x1000x730	250x1400x730	250x1400x730	250x1400x730
Net weight		kg	25	25	30	30	39	39	39
nanoe X Generator			Mark 2	Mark 2	Mark 2	Mark 2	Mark 2	Mark 2	Mark 2
Outdoor unit			U-36PZH3E5	U-50PZH3E5	U-60PZH3E5	U-71PZH4E5	U-100PZH4E5	U-125PZH4E5	U-140PZH4E5
Power supply		V	220 - 230 - 240	220 - 230 - 240	220 - 230 - 240	220 - 230 - 240	220 - 230 - 240	220 - 230 - 240	220 - 230 - 240
Current	Cool	A	4,20 - 4,00 - 3,85	6,90 - 6,60 - 6,35	7,25 - 6,95 - 6,65	9,20 - 8,80 - 8,45	11,50 - 11,00 - 10,50	16,80 - 16,00 - 15,40	19,40 - 18,50 - 17,70
	Heat	A	4,70 - 4,50 - 4,30	7,35 - 7,00 - 6,75	8,65 - 8,30 - 7,95	9,40 - 9,00 - 8,60	13,60 - 13,10 - 12,60	19,10 - 18,20 - 17,50	22,70 - 21,70 - 20,80
Air flow	Cool / Heat	m ³ /min	34,1/36,4	42,0/42,0	42,0/42,0	62,0/66,0	76,0/70,0	86,0/78,0	89,0/83,0
Sound pressure	Cool / Heat (Hi)	dB(A)	43/44	46/48	47/50	48/50	52/52	55/55	56/56
Sound power	Cool / Heat (Hi)	dB(A)	62/64	64/67	65/69	65/67	69/69	73/73	74/74
Dimension	HxWxD	mm	695x875x320	695x875x320	695x875x320	996x980x370	996x980x370	996x980x370	996x980x370
Net weight		kg	42	42	43	66	84	86	86
Piping diameter	Liquid	Inch (mm)	1/4 (6,35)	1/4 (6,35)	1/4 (6,35) ⁷⁾	3/8 (9,52)	3/8 (9,52)	3/8 (9,52)	3/8 (9,52)
	Gas	Inch (mm)	1/2 (12,70)	1/2 (12,70)	1/2 (12,70) ⁸⁾	5/8 (15,88)	5/8 (15,88)	5/8 (15,88)	5/8 (15,88)
Pipe length range		m	3 - 40	3 - 40	3 - 40	5 - 60	5 - 100	5 - 100	5 - 100
Elevation difference (in / out) ⁹⁾		m	15/30	15/30	15/30	15/30	15/30	15/30	15/30
Pre-charged pipe length		m	30	30	30	30	30	30	30
Additional gas amount		g/m	15	15	15	30	40	40	40
Refrigerant (R32) / CO ₂ Eq.		kg / T	1,13/0,76	1,13/0,76	1,15/0,78	1,95/1,32	2,70/1,82	3,00/2,03	3,00/2,03
Operating range	Cool Min ~ Max	°C	-15 ~ +46	-15 ~ +46	-15 ~ +46	-15 ~ +52	-20 ¹⁰⁾ ~ +52	-20 ¹⁰⁾ ~ +52	-20 ¹⁰⁾ ~ +52
	Heat Min ~ Max	°C	-20 ~ +24	-20 ~ +24	-20 ~ +24	-20 ~ +24	-20 ~ +24	-20 ~ +24	-20 ~ +24

Technical focus

- 2 installation possibilities (horizontal / vertical)
- Maximum external static pressure: 150 Pa
- Selectable inlet air position (rear / bottom entry)
- Improved drain pan suitable for both horizontal / vertical installation
- Drain pump included
- nanoe™ X (Generator Mark 2: 9,6 trillion hydroxyl radicals/sec) as standard for the long duct piping case*
- BION air pollutant filter for certain types of pollutants, such as nitrogen dioxide (NO₂), nitrogen oxides (NO_x) and Ozone (O₃) (optional)
- Wired remote control CZ-RTC6WBL and CZ-RTC6BL allows easy system setting via Bluetooth®

* The performance of nanoe™ X air can be expected even by 10 m long duct by Panasonic internal survey.

2 installation possibilities (horizontal / vertical)

Vertical installation is available. External static pressure 150 Pa, sufficient for remotely installing units away from the rooms.



Improved drain pan design

Just one drain pan for both horizontal and vertical installations. No need to modify the unit.

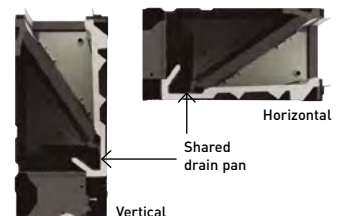

CZ-RTC5B



+ COMPATIBLE WITH ALL PANASONIC CONNECTIVITY SOLUTIONS. FOR DETAILED INFORMATION GO TO THE CONTROL SYSTEMS SECTION

Optional:



CONEX wired remote controller, white. CZ-RTC6W/BL/BLW2



CONEX wired remote controller, black. CZ-RTC6/BL/BLW2



Infrared remote controller. CZ-RWS3 + CZ-RWRC3



Econavi sensor. CZ-CENSC1

Three phase

			7,1 kW	10,0 kW	12,5 kW	14,0 kW
Kit			KIT-71PF3ZH48	KIT-100PF3ZH48	KIT-125PF3ZH48	KIT-140PF3ZH48
Remote controller			CZ-RTC5B	CZ-RTC5B	CZ-RTC5B	CZ-RTC5B
Cooling capacity	Nominal (Min - Max)	kW	6,8 [2,2 - 7,8]	9,5 [3,1 - 11,4]	12,1 [3,2 - 13,6]	13,4 [3,3 - 15,3]
EER ¹⁾	Nominal (Min - Max)	W/W	3,74 [2,41 - 5,64]	4,09 [2,82 - 5,08]	3,53 [3,00 - 5,00]	3,38 [2,59 - 4,18]
SEER / $\eta_{s,c}$²⁾			7,1 A++	7,4 A++	281,0%	275,2%
Pdesign		kW	6,8	9,5	12,1	13,4
Input power	Nominal (Min - Max)	kW	1,82 [0,39 - 3,24]	2,32 [0,61 - 4,04]	3,43 [0,64 - 4,54]	3,96 [0,79 - 5,90]
Annual energy consumption ³⁾		kWh/a	332	447	—	—
Heating capacity	Nominal (Min - Max)	kW	7,5 [2,0 - 9,0]	10,8 [3,1 - 13,5]	13,5 [3,2 - 15,4]	15,5 [3,3 - 17,4]
Heating capacity at -15 °C ⁴⁾	Max	kW	7,5	11,5	12,9	14,5
COP ¹⁾	Nominal (Min - Max)	W/W	4,03 [3,16 - 5,41]	3,88 [3,07 - 5,25]	3,46 [3,06 - 5,16]	3,33 [3,14 - 4,29]
SCOP / $\eta_{s,h}$²⁾			4,7 A++	4,3 A+	165,0%	162,6%
Pdesign at -10 °C		kW	4,7	7,8	9,3	9,5
Input power	Nominal (Min - Max)	kW	1,86 [0,37 - 2,85]	2,78 [0,59 - 4,40]	3,90 [0,62 - 5,04]	4,65 [0,77 - 5,55]
Annual energy consumption ³⁾		kWh/a	1394	2540	—	—
Indoor unit			S-6071PF3E	S-1014PF3E	S-1014PF3E	S-1014PF3E
External static pressure ⁵⁾	Nominal (Min - Max)	Pa	30 [10 - 150]	40 [10 - 150]	50 [10 - 150]	50 [10 - 150]
Air flow	Hi / Med / Lo	m ³ /min	21,0 / 19,0 / 15,0	32,0 / 26,0 / 21,0	34,0 / 29,0 / 23,0	36,0 / 32,0 / 25,0
Moisture removal volume		L/h	2,7	3,2	4,1	4,9
Sound pressure ⁶⁾	Hi / Med / Lo	dB(A)	30 / 26 / 23	33 / 29 / 25	35 / 31 / 27	39 / 35 / 29
Sound power	Hi / Med / Lo	dB(A)	53 / 49 / 46	56 / 52 / 48	58 / 54 / 50	62 / 58 / 52
Dimension	H x W x D	mm	250 x 1000 x 730	250 x 1400 x 730	250 x 1400 x 730	250 x 1400 x 730
Net weight		kg	30	39	39	39
nanoe X Generator			Mark 2	Mark 2	Mark 2	Mark 2
Outdoor unit			U-71PZH4E8	U-100PZH4E8	U-125PZH4E8	U-140PZH4E8
Power supply		V	380 - 400 - 415	380 - 400 - 415	380 - 400 - 415	380 - 400 - 415
Current	Cool	A	3,05 - 2,90 - 2,80	3,85 - 3,70 - 3,50	5,65 - 5,40 - 5,20	6,55 - 6,20 - 6,00
	Heat	A	3,15 - 3,00 - 2,90	4,65 - 4,40 - 4,20	6,50 - 6,20 - 5,95	7,75 - 7,40 - 7,05
Air flow	Cool / Heat	m ³ /min	62,0 / 66,0	76,0 / 70,0	86,0 / 78,0	89,0 / 83,0
Sound pressure	Cool / Heat (Hi)	dB(A)	48 / 50	52 / 52	55 / 55	56 / 56
Sound power	Cool / Heat (Hi)	dB(A)	65 / 67	69 / 69	73 / 73	74 / 74
Dimension	H x W x D	mm	996 x 980 x 370	996 x 980 x 370	996 x 980 x 370	996 x 980 x 370
Net weight		kg	66	82	84	84
Piping diameter	Liquid	Inch (mm)	3/8 (9,52)	3/8 (9,52)	3/8 (9,52)	3/8 (9,52)
	Gas	Inch (mm)	5/8 (15,88)	5/8 (15,88)	5/8 (15,88)	5/8 (15,88)
Pipe length range		m	5 - 60	5 - 100	5 - 100	5 - 100
Elevation difference (in / out) ⁹⁾		m	15 / 30	15 / 30	15 / 30	15 / 30
Pre-charged pipe length		m	30	30	30	30
Additional gas amount		g/m	30	40	40	40
Refrigerant (R32) / CO ₂ Eq.		kg / T	1,95 / 1,32	2,70 / 1,82	3,00 / 2,03	3,00 / 2,03
Operating range	Cool Min ~ Max	°C	-15 ~ +52	-20 ¹⁰⁾ ~ +52	-20 ¹⁰⁾ ~ +52	-20 ¹⁰⁾ ~ +52
	Heat Min ~ Max	°C	-20 ~ +24	-20 ~ +24	-20 ~ +24	-20 ~ +24

1) EER and COP calculation is based in accordance to EN 14511. 2) For models below 12 kW, the SEER and SCOP is calculated based on values of EU/626/2011. For models above 12 kW, the $\eta_{s,c}$ / $\eta_{s,h}$ values is calculated based on EN 14825. 3) Factory setting. 4) The value is based on the interpolation. 5) Medium external static pressure setting from factory. 6) The sound pressure of the units shows the value measured of the position 1,5 m below the unit. The sound pressure is measured in accordance with Eurovent 6/C/006-97 specification. 7) Connect the liquid socket tube (Ø6,35-Ø9,52) to the liquid tubing side indoor unit. 8) Connect the gas socket tube (Ø12,70-Ø15,88) to the gas tubing side indoor unit. 9) Outdoor unit located lower / outdoor unit located higher. 10) Pipe length up to 30 m. * Recommended fuse for the indoor 3 A. ** Above values are in the case of standard installation (horizontal installation in the ceiling, rear side air intake) and nanoe™ X OFF.

Accessories

CZ-RTC6W	CONEX wired remote controller (non-wireless), white
CZ-RTC6WBL	CONEX wired remote controller with Bluetooth®, white
CZ-RTC6WBLW2	CONEX wired remote controller with Wi-Fi and Bluetooth®, white
CZ-RTC6	CONEX wired remote controller (non-wireless), black
CZ-RTC6BL	CONEX wired remote controller with Bluetooth®, black
CZ-RTC6BLW2	CONEX wired remote controller with Wi-Fi and Bluetooth®, black
CZ-RTC5B	Wired remote controller with Econavi function
CZ-RWS3 + CZ-RWRC3	Infrared remote controller and receiver
CZ-CAPWFC2	Commercial Wi-Fi Adaptor
PAW-PACR4	Interface to run up to 4 indoor unit groups on backup and alternative run

Accessories

PAW-WTRAY	Tray for condenser water compatible with outdoor elevation platform
PAW-GRDBSE20	Outdoor base ground support for noise and vibration absorption
PAW-GRDSTD40	Outdoor elevation platform 400 x 900 x 400 mm
CZ-CENSC1	Econavi energy saving sensor
CZ-56DAF2	Air outlet plenum for S-3650PF3E
CZ-90DAF2	Air outlet plenum for S-6071PF3E
CZ-160DAF2	Air outlet plenum for S-1014PF3E
PAW-APF800F	BION air pollutant filter for S-3650PF3E
PAW-APF1000F	BION air pollutant filter for S-6071PF3E
PAW-APF1400F	BION air pollutant filter for S-1014PF3E



SEER and SCOP: For S-6071PF3E + U-71PZH4E5. SUPER QUIET: For S-3650PF3E + U-36PZH3E5. INTERNET CONTROL: Optional.

Rating conditions: Cooling indoor 27 °C DB / 19 °C WB. Cooling outdoor 35 °C DB / 24 °C WB. Heating indoor 20 °C DB. Heating outdoor 7 °C DB / 6 °C WB. (DB: Dry Bulb; WB: Wet Bulb). Specifications subject to change without notice. For detailed information about ErP / Energy Labelling, please visit our websites www.aircon.panasonic.eu or www.ptc.panasonic.eu.

PACi NX Series Standard adaptive ducted unit - PF3 · R32

Adaptive ducted unit - PF3.

2 installation possibilities (horizontal / vertical) with high ESP 150Pa allows flexible installation.



			Single phase						
			3,6 kW	5,0 kW	6,0 kW	7,1 kW	10,0 kW	12,5 kW	14,0 kW
Kit			KIT-36PF3Z5	KIT-50PF3Z5	KIT-60PF3Z5	KIT-71PF3Z5	KIT-100PF3Z5	KIT-125PF3Z5	KIT-140PF3Z5
Remote controller			CZ-RTC5B	CZ-RTC5B	CZ-RTC5B	CZ-RTC5B	CZ-RTC5B	CZ-RTC5B	CZ-RTC5B
Cooling capacity	Nom (Min - Max)	kW	3,4(1,5 - 4,0)	5,0(1,5 - 5,3)	5,7(2,0 - 6,3)	6,8(2,6 - 7,7)	9,5(3,0 - 11,4)	12,1(3,2 - 13,5)	13,4(3,3 - 15,0)
EER ¹⁾	Nom (Min - Max)	W/W	3,78(3,51 - 5,00)	2,78(2,76 - 4,63)	3,54(2,63 - 5,88)	3,18(2,69 - 4,56)	3,57(2,36 - 5,08)	3,40(2,76 - 5,08)	3,16(2,56 - 5,08)
SEER / η_{s,c}²⁾			6,0 A+	6,5 A++	6,4 A++	6,0 A+	6,6 A++	257,4%	252,2%
Pdesign		kW	3,4	5,0	5,7	6,8	9,5	12,1	13,4
Input power	Nom (Min - Max)	kW	0,90(0,30 - 1,14)	1,80(0,32 - 1,92)	1,61(0,34 - 2,40)	2,14(0,57 - 2,86)	2,66(0,59 - 4,84)	3,56(0,63 - 4,90)	4,24(0,65 - 5,86)
Annual energy consumption ³⁾		kWh/a	198	267	310	391	502	—	—
Heating capacity	Nom (Min - Max)	kW	3,4(1,5 - 4,6)	5,0(1,5 - 5,9)	5,7(1,8 - 7,0)	6,8(2,1 - 8,1)	9,5(3,0 - 13,5)	12,1(3,3 - 15,0)	13,4(3,4 - 16,0)
Heating capacity at -15 °C ⁴⁾	Max	kW	2,6	3,5	4,7	4,8	8,0	10,5	10,8
COP ¹⁾	Nom (Min - Max)	W/W	4,15(3,51 - 5,36)	3,62(3,06 - 5,36)	4,04(2,82 - 6,21)	4,00(3,03 - 5,68)	4,09(3,00 - 5,08)	3,56(3,16 - 5,24)	3,76(3,03 - 5,23)
SCOP / η_{s,h}²⁾			4,0 A+	4,0 A+	4,4 A+	4,1 A+	3,9 A	142,6%	140,6%
Pdesign at -10 °C		kW	2,4	3,8	4,4	4,7	7,8	9,3	9,5
Input power	Nom (Min - Max)	kW	0,82(0,28 - 1,31)	1,38(0,28 - 1,73)	1,41(0,29 - 2,48)	1,70(0,37 - 2,67)	2,32(0,59 - 4,50)	3,40(0,63 - 4,74)	3,56(0,65 - 5,28)
Annual energy consumption ³⁾		kWh/a	839	1303	1376	1591	2795	—	—
Indoor unit			S-3650PF3E	S-3650PF3E	S-6071PF3E	S-6071PF3E	S-1014PF3E	S-1014PF3E	S-1014PF3E
External static pressure ⁵⁾	Nom (Min - Max)	Pa	30(10 - 150)	30(10 - 150)	30(10 - 150)	30(10 - 150)	40(10 - 150)	50(10 - 150)	50(10 - 150)
Air flow	Hi / Med / Lo	m ³ /min	14,0/13,0/10,0	16,0/15,0/12,0	21,0/19,0/15,0	21,0/19,0/15,0	32,0/26,0/21,0	34,0/29,0/23,0	36,0/32,0/25,0
Moisture removal volume		L/h	0,9	1,9	1,7	2,7	3,2	4,1	4,9
Sound pressure ⁶⁾	Hi / Med / Lo	dB(A)	30/27/22	34/30/25	30/26/23	30/26/23	33/29/25	35/31/27	39/35/29
Sound power	Hi / Med / Lo	dB(A)	53/50/45	57/53/48	53/49/46	53/49/46	56/52/48	58/54/50	62/58/52
Dimension	HxWxD	mm	250x800x730	250x800x730	250x1000x730	250x1000x730	250x1400x730	250x1400x730	250x1400x730
Net weight		kg	25	25	30	30	39	39	39
nanoe X Generator			Mark 2	Mark 2	Mark 2	Mark 2	Mark 2	Mark 2	Mark 2
Outdoor unit			U-36PZ3E5	U-50PZ3E5	U-60PZ3E5A	U-71PZ3E5A	U-100PZ3E5	U-125PZ3E5	U-140PZ3E5
Power supply	V		220 - 230 - 240	220 - 230 - 240	220 - 230 - 240	220 - 230 - 240	220 - 230 - 240	220 - 230 - 240	220 - 230 - 240
Current	Cool	A	4,15-4,00-3,85	8,35-8,00-7,65	7,45-7,15-6,85	9,95-9,50-9,10	13,30-12,70-12,20	17,20-16,40-15,80	20,50-19,60-18,8
	Heat	A	3,85-3,70-3,50	6,45-6,20-5,95	6,55-6,25-6,00	7,90-7,55-7,25	11,60-11,10-10,60	16,40-15,70-15,00	17,20-16,40-15,80
Air flow	Cool / Heat	m ³ /min	33,6/34,0	32,7/31,9	42,6/41,5	44,7/45,9	73,0/73,0	82,0/80,0	84,0/82,0
Sound pressure	Cool / Heat (Hi)	dB(A)	46/47	46/46	47/48	48/49	52/52	55/55	56/56
Sound power	Cool / Heat (Hi)	dB(A)	64/66	64/64	64/65	66/68	70/70	73/73	74/74
Dimension	HxWxD	mm	619x824x299	619x824x299	695x875x320	695x875x320	996x980x370	996x980x370	996x980x370
Net weight		kg	32	35	42	50	83	87	87
Piping diameter	Liquid	Inch (mm)	1/4(Ø6,35)	1/4(Ø6,35)	1/4(Ø6,35) ⁷⁾	1/4(Ø6,35) ⁷⁾	3/8(9,52)	3/8(9,52)	3/8(9,52)
	Gas	Inch (mm)	1/2(Ø12,7)	1/2(Ø12,7)	1/2(Ø12,7) ⁸⁾	5/8(Ø15,88)	5/8(15,88)	5/8(15,88)	5/8(15,88)
Pipe length range	m		3 - 15	3 - 20	3 - 40	3 - 40	5 - 50	5 - 50	5 - 50
Elevation difference (in / out) ⁹⁾	m		15/15	15/15	15/30	20/30	15/30	15/30	15/30
Pre-charged pipe length	m		7,5	7,5	30	30	30	30	30
Additional gas amount	g/m		10	15	15	17	45	45	45
Refrigerant (R32) / CO ₂ Eq.	kg / T		0,87/0,59	1,14/0,77	1,15/0,78	1,32/0,89	2,40/1,62	2,80/1,89	2,80/1,89
Operating range	Cool Min ~ Max	°C	-10 ~ +43	-10 ~ +43	-10 ~ +43	-10 ~ +43	-10 ~ +43	-10 ~ +43	-10 ~ +43
	Heat Min ~ Max	°C	-15 ~ +24	-15 ~ +24	-15 ~ +24	-15 ~ +24	-15 ~ +24	-15 ~ +24	-15 ~ +24

Technical focus

- 2 installation possibilities (horizontal / vertical)
- Maximum external static pressure: 150 Pa
- Selectable inlet air position (rear / bottom entry)
- Improved drain pan suitable for both horizontal / vertical installation
- Drain pump included
- nanoe™ X (Generator Mark 2: 9,6 trillion hydroxyl radicals/sec) as standard for the long duct piping case*
- BION air pollutant filter for certain types of pollutants, such as nitrogen dioxide (NO₂), nitrogen oxides (NO_x) and Ozone (O₃) (optional)
- Wired remote control CZ-RTC6WBL and CZ-RTC6BL allows easy system setting via Bluetooth®

* The performance of nanoe™ X air can be expected even by 10 m long duct by Panasonic internal survey.

2 installation possibilities (horizontal / vertical)

Vertical installation is available. External static pressure 150 Pa, sufficient for remotely installing units away from the rooms.



Improved drain pan design

Just one drain pan for both horizontal and vertical installations. No need to modify the unit.

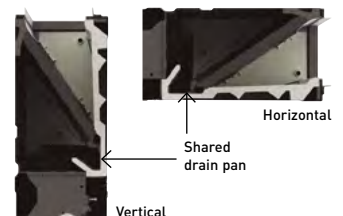

CZ-RTC5B



COMPATIBLE WITH ALL PANASONIC CONNECTIVITY SOLUTIONS. FOR DETAILED INFORMATION GO TO THE CONTROL SYSTEMS SECTION

Optional:



CONEX wired remote controller, white. CZ-RTC6W/BL/BLW2



CONEX wired remote controller, black. CZ-RTC6/BL/BLW2



Infrared remote controller. CZ-RWS3 + CZ-RWRC3

Econavi sensor. CZ-CENSC1

Kit	Three phase			
	10,0 kW	12,5 kW	14,0 kW	
Kit	KIT-100PF3Z8	KIT-125PF3Z8	KIT-140PF3Z8	
Remote controller	CZ-RTC5B	CZ-RTC5B	CZ-RTC5B	
Cooling capacity	Nominal (Min - Max) kW	9,5(3,0 - 11,4)	12,1(3,2 - 13,5)	13,4(3,3 - 15,0)
EER ¹⁾	Nominal (Min - Max) W/W	3,57(2,36 - 5,08)	3,40(2,76 - 5,08)	3,16(2,56 - 5,08)
SEER / η_{s,c}²⁾		6,5 A++	256,2%	251,4%
Pdesign	kW	9,5	12,1	13,4
Input power	Nominal (Min - Max) kW	2,66(0,59 - 4,84)	3,56(0,63 - 4,90)	4,24(0,65 - 5,86)
Annual energy consumption ³⁾	kWh/a	508	—	—
Heating capacity	Nominal (Min - Max) kW	9,5(3,0 - 13,5)	12,1(3,3 - 15,0)	13,4(3,4 - 16,0)
Heating capacity at -15 °C ⁴⁾	Max kW	8,0	10,5	10,8
COP ¹⁾	Nominal (Min - Max) W/W	4,09(3,00 - 5,08)	3,56(3,16 - 5,24)	3,76(3,03 - 5,23)
SCOP / η_{s,h}²⁾		3,9 A	142,6%	140,6%
Pdesign at -10 °C	kW	7,8	9,3	9,5
Input power	Nominal (Min - Max) kW	2,32(0,59 - 4,50)	3,40(0,63 - 4,74)	3,56(0,65 - 5,28)
Annual energy consumption ³⁾	kWh/a	2795	—	—
Indoor unit		S-1014PF3E	S-1014PF3E	S-1014PF3E
External static pressure ⁵⁾	Nominal (Min - Max) Pa	40(10 - 150)	50(10 - 150)	50(10 - 150)
Air flow	Hi / Med / Lo m ³ /min	32,0/26,0/21,0	34,0/29,0/23,0	36,0/32,0/25,0
Moisture removal volume	L/h	3,2	4,1	4,9
Sound pressure ⁶⁾	Hi / Med / Lo dB(A)	33/29/25	35/31/27	39/35/29
Sound power	Hi / Med / Lo dB(A)	56/52/48	58/54/50	62/58/52
Dimension	H x W x D mm	250 x 1400 x 730	250 x 1400 x 730	250 x 1400 x 730
Net weight	kg	39	39	39
nanoe X Generator		Mark 2	Mark 2	Mark 2
Outdoor unit		U-100PZ3E8	U-125PZ3E8	U-140PZ3E8
Power supply	V	380 - 400 - 415	380 - 400 - 415	380 - 400 - 415
Current	Cool A	4,45 - 4,20 - 4,05	5,75 - 5,45 - 5,25	6,85 - 6,50 - 6,30
	Heat A	3,85 - 3,70 - 3,55	5,50 - 5,20 - 5,05	5,75 - 5,45 - 5,25
Air flow	Cool / Heat m ³ /min	73,0/73,0	82,0/80,0	84,0/82,0
Sound pressure	Cool / Heat (Hi) dB(A)	52/52	55/55	56/56
Sound power	Cool / Heat (Hi) dB(A)	70/70	73/73	74/74
Dimension	H x W x D mm	996 x 980 x 370	996 x 980 x 370	996 x 980 x 370
Net weight	kg	83	87	87
Piping diameter	Liquid Inch (mm)	3/8(9,52)	3/8(9,52)	3/8(9,52)
	Gas Inch (mm)	5/8(15,88)	5/8(15,88)	5/8(15,88)
Pipe length range	m	5 - 50	5 - 50	5 - 50
Elevation difference (in / out) ⁷⁾	m	15/30	15/30	15/30
Pre-charged pipe length	m	30	30	30
Additional gas amount	g/m	45	45	45
Refrigerant (R32) / CO ₂ Eq.	kg / T	2,40/1,62	2,80/1,89	2,80/1,89
Operating range	Cool Min ~ Max °C	-10 ~ +43	-10 ~ +43	-10 ~ +43
	Heat Min ~ Max °C	-15 ~ +24	-15 ~ +24	-15 ~ +24

1) EER and COP calculation is based in accordance to EN 14511. 2) For models below 12 kW, the SEER and SCOP is calculated based on values of EU/626/2011. For models above 12 kW, the η_{s,c} / η_{s,h} values is calculated based on EN 14825. 3) Factory setting. 4) The value is based on the interpolation. 5) Medium external static pressure setting from factory. 6) The sound pressure of the units shows the value measured of the position 1,5 m below the unit. The sound pressure is measured in accordance with Eurovent 6/C/006-97 specification. 7) Connect the liquid socket tube (Ø6,35-Ø9,52) to the liquid tubing side indoor unit. 8) Connect the gas socket tube (Ø12,70-Ø15,88) to the gas tubing side indoor unit. 9) Outdoor unit located lower / outdoor unit located higher. * Recommended fuse for the indoor 3 A. ** Above values are in the case of standard installation(horizontal installation in the ceiling, rear side air intake) and nanoe™ X OFF.

Accessories

CZ-RTC6W	CONEX wired remote controller (non-wireless), white
CZ-RTC6WBL	CONEX wired remote controller with Bluetooth®, white
CZ-RTC6WBLW2	CONEX wired remote controller with Wi-Fi and Bluetooth®, white
CZ-RTC6	CONEX wired remote controller (non-wireless), black
CZ-RTC6BL	CONEX wired remote controller with Bluetooth®, black
CZ-RTC6BLW2	CONEX wired remote controller with Wi-Fi and Bluetooth®, black
CZ-RTC5B	Wired remote controller with Econavi function
CZ-RWS3 + CZ-RWRC3	Infrared remote controller and receiver
CZ-CAPWFC2	Commercial Wi-Fi Adaptor
PAW-PACR4	Interface to run up to 4 indoor unit groups on backup and alternative run

Accessories

PAW-WTRAY	Tray for condenser water compatible with outdoor elevation platform
PAW-GRDBSE20	Outdoor base ground support for noise and vibration absorption
PAW-GRDSTD40	Outdoor elevation platform 400 x 900 x 400 mm
CZ-CENSC1	Econavi energy saving sensor
CZ-56DAF2	Air outlet plenum for S-3650PF3E
CZ-90DAF2	Air outlet plenum for S-6071PF3E
CZ-160DAF2	Air outlet plenum for S-1014PF3E
PAW-APF800F	BION air pollutant filter for S-3650PF3E
PAW-APF1000F	BION air pollutant filter for S-6071PF3E
PAW-APF1400F	BION air pollutant filter for S-1014PF3E



SEER: For S-1014PF3E + U-100PZ3E5. SCOP: For S-6071PF3E + U-60PZ3E5A. SUPER QUIET: For S-3650PF3E + U-36PZ3E5. INTERNET CONTROL: Optional.

Rating conditions: Cooling indoor 27 °C DB / 19 °C WB. Cooling outdoor 35 °C DB / 24 °C WB. Heating indoor 20 °C DB. Heating outdoor 7 °C DB / 6 °C WB. (DB: Dry Bulb; WB: Wet Bulb). Specifications subject to change without notice. For detailed information about ErP / Energy Labelling, please visit our websites www.aircon.panasonic.eu or www.ptc.panasonic.eu.

Big PACi NX high static pressure hide-away 20,0-25,0 kW · R32

Optional:



			Three phase	
			20,0 kW	25,0 kW
Kit			KIT-200PE4ZH8	KIT-250PE4ZH8
Remote controller			CZ-RTC5B	CZ-RTC5B
Cooling capacity	Nominal (Min - Max)	kW	19,0 (5,7 - 20,0)	22,0 (6,1 - 25,6)
EER ¹⁾	Nominal (Min - Max)	W/W	3,20 (2,78 - 4,60)	2,74 (2,49 - 4,88)
$\eta_{s,c}$ ²⁾			237,8%	213,0%
Pdesign		kW	19,0	22,0
Input power	Nominal (Min - Max)	kW	5,93 (1,24 - 7,20)	8,04 (1,25 - 10,30)
Heating capacity	Nominal (Min - Max)	kW	22,4 (5,0 - 24,5)	24,0 (5,5 - 27,6)
Heating capacity at -15 °C ³⁾	Max	kW	16,8	19,0
COP ¹⁾	Nominal (Min - Max)	W/W	3,55 (3,27 - 4,76)	3,55 (3,07 - 4,78)
$\eta_{s,h}$ ²⁾			146,0%	145,0%
Pdesign at -10 °C		kW	16,0	17,2
Input power	Nominal (Min - Max)	kW	6,31 (1,05 - 7,50)	6,76 (1,15 - 9,00)
Indoor unit			S-200PE4E	S-250PE4E
External static pressure at shipment (adjustable)		Pa	75 ⁴⁾ (120 / 180)	75 ⁴⁾ (130 / 200)
Air flow	Hi / Med / Lo	m ³ /min	72/63/53	84/72/59
Sound pressure ⁵⁾	Hi / Med / Lo	dB(A)	46/44/41	47/45/42
Dimension / Net weight	H x W x D	mm / kg	486 x 1456 x 916 / 83	486 x 1456 x 916 / 87
nanoe X Generator			Mark 3	Mark 3
Outdoor unit			U-200PZH4E8	U-250PZH4E8
Power supply		V / ph / Hz	380 - 400 - 415 / 3 / 50	380 - 400 - 415 / 3 / 50
Recommended fuse		A	30	30
Air flow	Cool / Heat	m ³ /min	116 / 136	116 / 148
Sound pressure	Cool / Heat (Hi)	dB(A)	57 / 61	57 / 63
Sound power	Cool / Heat (Hi)	dB(A)	76 / 80	76 / 82
Dimension ⁶⁾ / Net weight	H x W x D	mm / kg	996 x 1140 x 460 / 109	996 x 1140 x 460 / 109
Piping diameter	Liquid / Gas	Inch (mm)	1/2 (12,7) / 7/8 (22,22)	1/2 (12,7) / 7/8 (22,22)
Pipe length range / Elevation difference (in / out)		m / m	5 - 100 / 30	5 - 100 / 30
Pre-charged pipe length / Additional gas amount		m / g/m	30 / 80	30 / 80
Refrigerant (R32) / CO ₂ Eq.		kg / T	4,8 / 3,24	4,8 / 3,24
Operating range	Cool Min ~ Max	°C	-15 ~ +52	-15 ~ +52
	Heat Min ~ Max	°C	-20 ~ +35	-20 ~ +35

1) EER and COP calculation is based in accordance to EN 14511. 2) Energy Label Scale from A+++ to D. For models above 12 kW, the $\eta_{s,c}$ / $\eta_{s,h}$ values is calculated based on EN 14825. 3) The value is based on the interpolation. 4) Factory setting. 5) The sound pressure of the units shows the value measured of the position 1,5 m below the unit. The sound pressure is measured in accordance with Eurovent 6/C/006-97 specification. 6) Add 100 mm for indoor unit or 70 mm for outdoor unit for piping port.

Accessories	
CZ-RTC6W	CONEX wired remote controller (non-wireless), white
CZ-RTC6WBL	CONEX wired remote controller with Bluetooth®, white
CZ-RTC6WBLW2	CONEX wired remote controller with Wi-Fi and Bluetooth®, white
CZ-RTC6	CONEX wired remote controller (non-wireless), black
CZ-RTC6BL	CONEX wired remote controller with Bluetooth®, black
CZ-RTC6BLW2	CONEX wired remote controller with Wi-Fi and Bluetooth®, black
CZ-RTC5B	Wired remote controller with Econavi function

Accessories	
CZ-RWS3 + CZ-RWRC3	Infrared remote controller and receiver
CZ-CAPWFC2	Commercial Wi-Fi Adaptor
PAW-PACR4	Interface to run up to 4 indoor unit groups on backup and alternative run
PAW-GRDSTD1100	Outdoor ground stand
PAW-GRDBSE20	Outdoor base ground support for noise and vibration absorption
CZ-CENSC1	Econavi energy saving sensor

Demand response compliant as a standard function

Several setting levels are available:

- Level-1, 2, 3: 75 / 50 / 0%
 - Level-1, 2 can be set in 40 - 100% (40, 45, 50...95, 100: each 5%)
- It allows for forced stop which can be used for fire-alarm connection on LV3.

* PAW-OPT-NX is required.

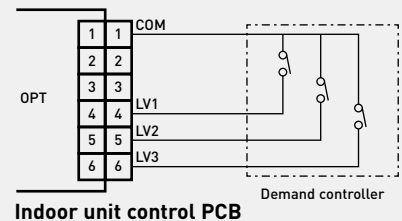

Indoor unit control PCB

COMPATIBLE WITH ALL PANASONIC CONNECTIVITY SOLUTIONS. FOR DETAILED INFORMATION GO TO THE CONTROL SYSTEMS SECTION

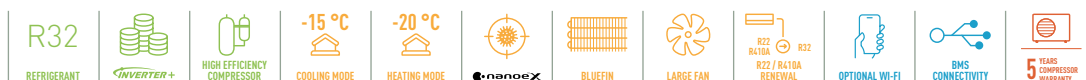

INTERNET CONTROL: Optional.

PACi NX Jet Air Stream · R32

- Energy-saving solution for year-round heating and cooling in large and high spaces
- High air volume up to 5000 m³/h and long maximum air throw distance of 30 m
- Optimal comfort with Smart Jet - self-directing nozzles



Touch panel controller.
PCZ-AHRX0012

Air flow			2500 m ³ /h	2500 m ³ /h	5000 m ³ /h
Kit			KIT-140MC5ZH5	KIT-140MC5ZH8	KIT-250MC5ZH8
Remote controller			PCZ-AHRX0012	PCZ-AHRX0012	PCZ-AHRX0012
Cooling capacity	Nominal (Min - Max)	kW	14,1 [3,3 - 18,0]	14,1 [3,3 - 18,0]	24,2 [6,1 - 25,6]
EER ¹⁾	Nominal (Min - Max)	W/W	3,46 [2,74 - 5,32]	3,46 [2,74 - 5,32]	3,80 [2,49 - 4,88]
$\eta_{s,c}$ ²⁾			227%	227%	250%
Pdesign		kW	—	—	—
Heating capacity	Nominal (Min - Max)	kW	14,0 [3,3 - 18,0]	14,0 [3,3 - 18,0]	26,7 [5,5 - 27,6]
COP ¹⁾	Nominal (Min - Max)	W/W	3,88 [3,27 - 5,50]	3,88 [3,27 - 5,50]	3,74 [3,07 - 4,78]
$\eta_{s,h}$ ²⁾			155%	155%	155%
Pdesign at -10 °C		kW	11,0	11,0	18,5
			Jet Air Stream Smart	Jet Air Stream Smart	Jet Air Stream Smart
Indoor unit			P-VTVF140MC5-PE	P-VTVF140MC5-PE	P-VTVF250MC5-PE
Nozzles type			Smart Jet - self-directing nozzles	Smart Jet - self-directing nozzles	Smart Jet - self-directing nozzles
Number of nozzles			2	2	4
External static pressure			170	170	170
Air flow			2560	2560	5010
Sound pressure ³⁾	Cool / Heat	dB(A)	42	42	46
Sound power ⁴⁾	Hi / Med / Lo	dB(A)	—	—	—
Dimension	HxWxD	mm	802 x 1105 x 893	802 x 1105 x 893	1026 x 1458 x 953
Net weight		kg	88	88	130
Outdoor unit			U-140PZH4E5	U-140PZH4E8	U-250PZH4E8
Power supply	V / ph / Hz		220 - 230 - 240/1/50	380 - 400 - 415/3/50	380 - 400 - 415/3/50
Recommended fuse	A		40	16	30
Sound pressure	Cool / Heat (Hi)	dB(A)	56/56	56/56	59/63
Dimension	HxWxD	mm	996 x 980 x 370	996 x 980 x 370	996 x 1140 x 460
Net weight		kg	86	84	109
Piping diameter	Liquid	Inch (mm)	3/8 (9,52)	3/8 (9,52)	1/2 (12,70)
	Gas	Inch (mm)	5/8 (15,88)	5/8 (15,88)	7/8 (22,22)
Pipe length range		m	5 - 100	5 - 100	5 - 100
Elevation difference (in / out)		m	15/30 ⁵⁾	15/30 ⁵⁾	30
Pre-charged pipe length		m	30	30	30
Additional gas amount		g/m	40	40	80
Refrigerant (R32) / CO ₂ Eq.		kg / T	3,00/2,03	3,00/2,03	4,80/3,24
Operating range	Cool Min ~ Max	°C	-20 ⁶⁾ ~ +52	-20 ⁶⁾ ~ +52	-15 ~ +52
	Heat Min ~ Max	°C	-20 ~ +24	-20 ~ +24	-20 ~ +35

1) EER and COP calculation is based in accordance to EN 14511. 2) For models above 12 kW, the $\eta_{s,c}$ / $\eta_{s,h}$ values is calculated based on EN 14825. 3) Average sound pressure at 5 m Lp. 4) Radiated sound power at 5 m Lp. 5) Outdoor unit located lower / outdoor unit located higher. 6) Pipe length up to 30 m.

Optional configurations*	Front panel type	Air flow (m ³ /h)
P-VTVF140NC5-PE Jet Air Stream Standard	Manual nozzles	2500
P-VTVF250NC5-PE Jet Air Stream Standard	Manual nozzles	5000
P-VTVF140PC5-PE Jet Air Stream Ducted	Ducted front panel	2500
P-VTVF250PC5-PE Jet Air Stream Ducted	Ducted front panel	5000

* The product technical data is the same as Jet Air Stream Smart.

Accessories

PCZ-AHRX0012	Touch panel controller with Modbus integration and group control up to 8 units
PCZ-AHRP0681	Recessed mounting box for controller
A PCZ-AHRX0051	Ducted air intake plenum (1 x DN 355 mm) for VTVF140N and VTVF140P
A PCZ-AHRX0052	Ducted air intake plenum (2 x DN 355 mm) for VTVF250N and VTVF250P
B PCZ-AHRX0061	Ground air intake module (VTVF250 requires two of them)
C PCZ-AHRX0071	Air supply grille for ducts

Accessories for remote air intake configurations.

Manual version.

Ducted version.

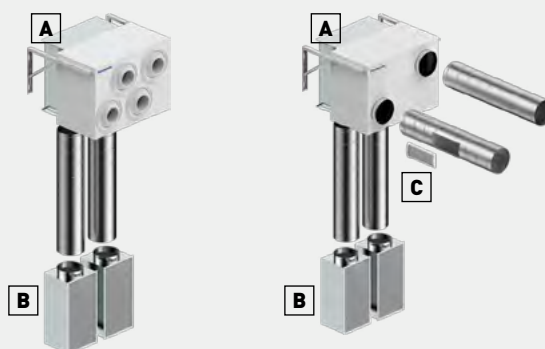

Rating conditions: Cooling indoor 27 °C DB / 19 °C WB. Cooling outdoor 35 °C DB / 24 °C WB. Heating indoor 20 °C DB. Heating outdoor 7 °C DB / 6 °C WB. (DB: Dry Bulb; WB: Wet Bulb). Specifications subject to change without notice. For detailed information about ErP / Energy Labelling, please visit our websites www.aircon.panasonic.eu or www.ptc.panasonic.eu.

Electric air curtain

The Panasonic range of air curtains is designed for smooth operation and efficient performance. Air curtains produce a continuous stream of air blown from the top to the bottom of an open doorway and create a barrier that people and products can flow across, but air cannot.



Model			FY-3009U1	FY-3012U1	FY-3015U1
Width	mm		900	1200	1500
Voltage	V		220	220	220
Air flow	Hi / Lo	m ³ /h	1100/920	1400/1270	2000/1800
Consumption	Hi / Lo	W	76/70	94/85	131/110
Current	Hi / Lo	A	0,35/0,32	0,43/0,40	0,59/0,50
Air speed	Hi / Lo	m/s	10,50/8,50	9,50/8,00	10,50/9,50
Sound pressure	Hi / Lo	dB(A)	48,5/45,0	48,5/44,5	51,5/48,0
Dimension	HxWxD	mm	900x231,5x212	1200x231,5x212	1500x231,5x212
Net weight		kg	12,0	14,5	18,0

1 Designed to maximize performance
High air flow upgraded 145% compared to conventional model (in the case of FY-3009U1).

3 Easier installation and maintenance
Simple structure for easy installation and maintenance.

2 Comprehensive product line up
1,5 m wide model added in the line up.



Air curtain with DX coil, connected to PACi NX

Comfort: Easy redirection of air flow by means of manual deflector.

Ease of use: Speed selector (high and low) on the unit itself.

Easy installation and maintenance: Easy installation / Compact dimensions improve installation and positioning / Easy cleaning of grid without opening of the unit.



Outdoor unit capacity			7,1 kW	10,0 kW	14,0 kW	20,0 kW
Air outlet height 2,7 m			PAW-10PAIRC-LS-1	PAW-15PAIRC-LS-1	PAW-20PAIRC-LS-1	PAW-25PAIRC-LS-1
Cooling capacity ¹⁾	Max	kW	6,1	9,7	13,0	17,0
Heating capacity ²⁾	Max	kW	7,9	12,0	15,0	19,0
Air flow	High	m ³ /h	1800	2700	3600	4500
Heat Exchanger	Volume	L	1,67	2,85	3,94	5,03
Electric consumption fan	230 V / 50 Hz	kW	0,30	0,50	0,60	0,80
Current	230 V / 50 Hz	A	2,10	3,10	4,10	5,10
Sound pressure ³⁾	Max	dB(A)	65	66	67	69
Air outlet height 3,0 m			PAW-10PAIRC-HS-1	PAW-15PAIRC-HS-1	PAW-20PAIRC-HS-1	PAW-25PAIRC-HS-1
Cooling capacity ¹⁾	Max	kW	9,1	13,0	19,5	23,7
Heating capacity ²⁾	Max	kW	11,8	15,8	23,6	27,6
Air flow	High	m ³ /h	2700	3600	5400	6300
Heat Exchanger	Volume	L	1,67	2,85	3,94	5,12
Electric consumption fan	230 V / 50 Hz	kW	0,75	1,00	1,50	1,75
Current	230 V / 50 Hz	A	4,10	5,50	8,20	9,60
Sound pressure ³⁾	Max	dB(A)	66	67	68	68
Common data						
Dimension ⁴⁾	H x W x D	mm	260 (+140) x 1000 x 460	260 (+140) x 1500 x 460	260 (+140) x 2000 x 460	260 (+140) x 2500 x 460
Net weight	Air outlet height 2,7 m	kg	50	65	80	95
	Air outlet height 3,0 m	kg	55	65	85	110
Fan type			EC	EC	EC	EC
Piping diameter	Liquid / Gas	Inch (mm)	3/8 (9,52) / 5/8 (15,88)	3/8 (9,52) / 3/4 (19,05)	3/8 (9,52) / 7/8 (22,22)	3/8 (9,52) / 7/8 (22,22)
Door width		m	1,0	1,5	2,0	2,5
Refrigerant			R32	R32	R32	R32

LS / PACi NX outdoor combination*	PACi NX Elite			PACi NX Standard		
	40 °C	35 °C	30 °C	40 °C	35 °C	30 °C
PAW-10PAIRC-LS-1	U-100	U-100	U-50	U-100	U-100	U-60
PAW-15PAIRC-LS-1	U-200	U-100	U-100	—	U-100	U-100
PAW-20PAIRC-LS-1	U-200	U-140	U-100	—	—	U-100
PAW-25PAIRC-LS-1	U-250	U-200	U-125	—	—	U-125

HS / PACi NX outdoor combination*	PACi NX Elite			PACi NX Standard		
	40 °C	35 °C	30 °C	40 °C	35 °C	30 °C
PAW-10PAIRC-HS-1	U-200	U-100	U-100	—	U-100	U-100
PAW-15PAIRC-HS-1	U-200	U-200	U-100	—	U-200	U-100
PAW-20PAIRC-HS-1	—	U-250	U-200	—	U-250	—
PAW-25PAIRC-HS-1	—	U-250	U-200	—	U-250	—

1) Cooling capacity DX coil, air temperature in / out +27 / +18 °C, R32 and R410. 2) Heating capacity condenser, air temperature in / out +20 / +33 °C, R32 and R410. In the case of lower outdoor temperatures, an outdoor model with higher capacity may be necessary. 3) Measured in distance up to 5,0 m, direction factor 2, absorbing surfaces 200 m², Min / Max air flow. 4) 140 mm is the height of an electrical box if it is installed on the top.

Technical focus

- Save up to 40% energy costs by use of the integrated EC fan technology (higher efficiency than conventional AC fan, soft start and longer motor duration)
- 4 length of air curtain LS and HS are available 1,0, 1,5, 2,0 and 2,5 m
- Installation height up to 3,0 m
- Outlet grilles can be adjusted in five positions, to suite different indoor and installation requirements
- Control with Panasonic remote control systems (optional)
- Direct integration to BMS via optional Panasonic interfaces
- Drip tray included in all DX air curtains
- Drain pump optional

How does it work?

Stale air from the room is taken in and ejected near the door. This creates a 'roll of air' that shields the door area, mixing with the colder incoming air. It then turns away from the door, back into the room and toward the intake screen, where it is partly drawn in again. This flow of air helps to create a barrier for heat loss yet at the same time refreshes room air

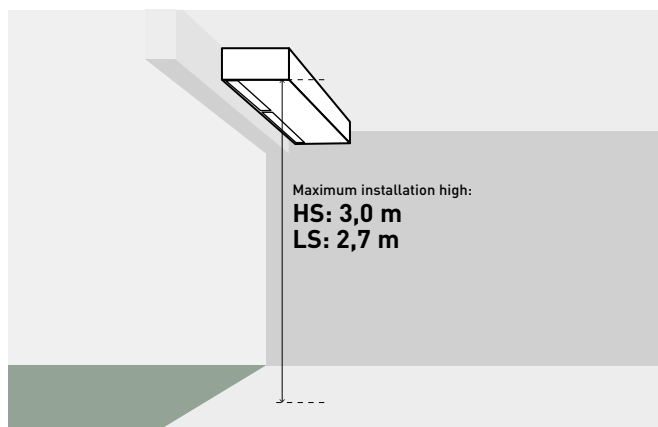

Rating Conditions: Cooling Outdoor +35 °C DB Indoor +27 °C DB / +19 °C WB, Discharge temperature 16 °C. All combinations under rated conditions: Heating Outdoor +7 °C DB/+6 °C WB Indoor +20 °C DB. In case of lower outdoor temperatures a higher capacity outdoor unit model may be necessary. Specifications subject to change without notice. For detailed information about ErP, please visit our websites www.aircon.panasonic.eu or www.ptc.panasonic.eu.

Ceiling mounted air-e nanoe X Generator

- nanoe™ X technology
(Generator Mark 1: 4,8 trillion hydroxyl radicals/sec)
- Silent operation. Whisper quiet at 25,5 dB(A)*
- Low power consumption 4 W
- Easy installation
- Compact and modern design

* 230 V.

air-e™



Model	FV-15CSD16				
Power supply	Voltage	V	220	230	240
	Frequency	Hz	50	50	50
Air flow	m³/h		15	16	17
	CFM		8,8	9,4	10,0
Consumption	W		4	4	4
Sound pressure	dB(A)		23,5	25,5	27,0
Net weight	kg			1,1	

* The value of air volume, power consumption and noise are specified at static pressure 0 Pa. The value of air volume is the mean value and a tolerance of +-10% is allowed. The value of noise level is a weighted average sound pressure level, the mean value is measured by Panasonic. A tolerance of +3 dB/-7 dB is allowed. The noise is measure at 1 m apart from the left, the front and below of the tested product. Conditions of generating nanoe™ X: room temperature: about 5 °C ~ 40 °C (dew point temperature more than 2 °C), relative humidity: about 30% ~ 85%. nanoe™ X is generated using the air in the room, and its amount is subject to the temperature and humidity in the air.

One device is suitable for around 20 m² (with a ceiling height 3 m)

Ex. 3 air-e devices are required for the room size 60 m².

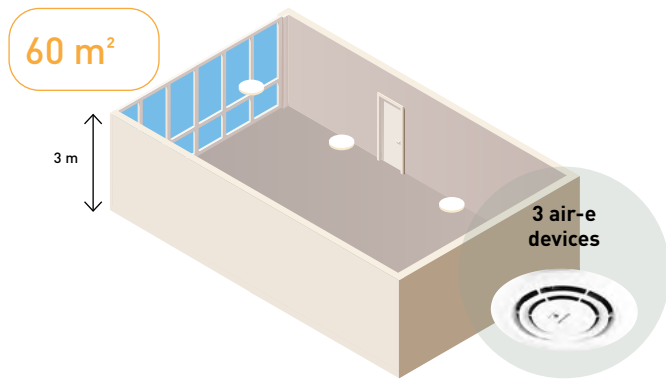

Concentration simulator is ready

See how nanoe™ X fills space.



The air-e is a stand alone device which is an easy and simple choice to improve indoor air quality. It can be easily installed to various commercial projects including refurbishments.

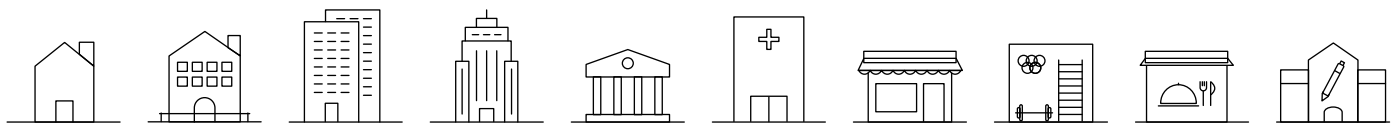

The tested effects of nanoe™ X

Bacteria and viruses.

SARS-CoV-2: 99,9% % inhibited ¹⁾

Influenza virus H1N1 subtype: 99,9 % inhibited ²⁾

Odour.

nanoe X Generator can reduce cigarette smoke odour intensity by 2,4 levels in 12 minutes.

- 1) Novel coronavirus [SARS-CoV-2] > [Test organization] Texcell [France] [Test subject] Adhered novel coronavirus [SARS-CoV-2] [Test volume] 45 L enclosed box [Test result] Inhibited 99,9% in 2 hours [Test report] 1140-01 A1.
- 2) Adhered virus [Influenza virus H1N1 subtype] > [Test organization] Kitasato Research Center for Environmental Science [Test subject] Influenza virus [H1N1 subtype] [Test volume] 1000 L enclosed box [Test result] Inhibited 99,9% in 2 hours [Test report] 21_0084_1.
- 3) Deodorisation effect for adhering odour [cigarette smoke] > [Test organization] Panasonic Product Analysis Center [Test subject] Adhered cigarette smoke odour [Test volume] Approx. 24 m³ laboratory [Test result] Odour intensity reduced 2,4 levels in 0,2 hours [Test report] 4AA33-160615-N04.

Performance of nanoe™ X might differ in real life environment and is only expected in the same room as where the unit is placed. The nanoe™ X performance varies depending on the room size, environment and usage and it may take several hours to reach the full effect. nanoe™ X is not a medical device.

Deodorisation effect for adhering odour (cigarette smoke) ³⁾

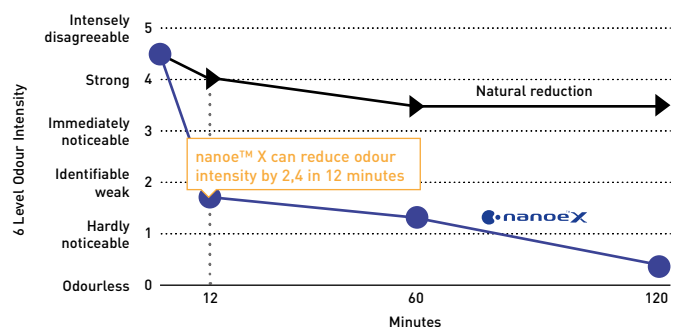

For further details and validation data, please refer to the following website.



Accessories and control

Drain kits

Drain kit to suit outdoor units from 3,6 to 7,1 kW.

CZ-50DRS1

Drain kit to suit outdoor units from 10,0 to 25 kW.

CZ-140DRS1

Branch Pipes, Header



Branch pipe.

CZ-P224BK2BM



Branch pipe (from 22,4 kW to 68 kW).

CZ-P680BK2BM



Header.

CZ-P3HPC2BM

Special outdoor supports

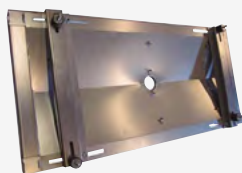

Tray for condenser water compatible with outdoor elevation platform.

PAW-WTRAY



Outdoor elevation platform.
Dimension (HxWxD): 400 x 900 x 400 mm

PAW-GRDSTD40



Outdoor base ground support for noise and vibration absorption.

Dimension (HxWxD): 600 x 95 x 130 mm
Safe working load: 500 kg

PAW-GRDBSE20

Panels



Panel for 4 way 60x60 cassette - PY3.

CZ-KPY4



Standard panel for 4 way 90x90 cassette, white (RAL9003).

CZ-KPU3



Econavi panel for 4 way 90x90 cassette, white (RAL9003).

CZ-KPU3A

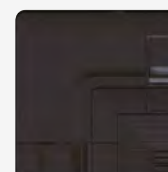

NEW Standard panel for 4 way 90x90 cassette, graphite black (RAL9011).

CZ-KPU3B

Sensors



Econavi energy saving sensor.

CZ-CENSC1



Remote temperature sensor.

CZ-CSRC3



Fresh air-intake kit.

CZ-FDU3+CZ-ATU2

IAQ filter for adaptive ducted unit



BION air pollutant filter for S-3650PF3E.

PAW-APF800F

BION air pollutant filter for S-6071PF3E.

PAW-APF1000F

BION air pollutant filter for S-1014PF3E.

PAW-APF1400F

Plenums

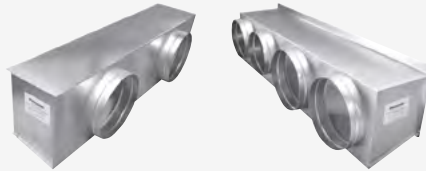

Air outlet plenum for S-3650PF3E.

CZ-56DAF2

Air outlet plenum for S-1014PF3E.

CZ-160DAF2

Air outlet plenum for S-200PE4E.

CZ-TREMIESPW705

Air outlet plenum for S-6071PF3E.

CZ-90DAF2

Air outlet plenum for S-250PE4E.

CZ-TREMIESPW706

VRF Smart Connectivity+



Remote controller Panasonic Net Con, RH, No PIR, R1/R2.

SER8150R0B1194

Remote controller Panasonic Net Con, RH, PIR, R1/R2.

SER8150R5B1194



Wireless ZigBee® Pro module / Green Com card.

VCM8000V5094P



Door/window wireless sensor.

SED-WDC-G-5045



Wall/ceiling motion/temperature/humidity sensor.

SED-MTH-G-5045



CO₂ sensor.

SED-CO2-G-5045









Sensor with room temperature and humidity.

SED-TRH-G-5045





Water leakage sensor.

SED-WLS-G-5045

 <p>Cover frame. Silver.</p> <p>----- FAS-00</p>	 <p>Cover frame. White.</p> <p>----- FAS-01</p>	 <p>Cover frame. Glossy translucent white.</p> <p>----- FAS-03</p>	 <p>Cover frame. Light tan wood.</p> <p>----- FAS-05</p>
 <p>Cover frame. Dark brown wood.</p> <p>----- FAS-06</p>	 <p>Cover frame. Dark black wood.</p> <p>----- FAS-07</p>	 <p>Cover frame. Brushed steel finish.</p> <p>----- FAS-10</p>	

Controller and touch controllers for hotels with dry contacts

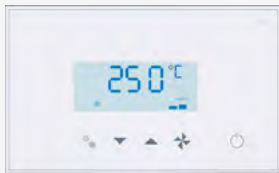



 <p>Modbus RS-485 touch room controller with I/O, white.</p> <p>----- PAW-RE2C4-MOD-WH</p> <p>Touch display control with 2 digital inputs, white.</p> <p>----- PAW-RE2D4-WH</p>	 <p>Modbus RS-485 touch room controller with I/O, black.</p> <p>----- PAW-RE2C4-MOD-BK</p> <p>Touch display control with 2 digital inputs, black.</p> <p>----- PAW-RE2D4-BK</p>
--	--

Hotel sensors for dry contacts

 <p>Wall silent motion sensor 24 V.</p> <p>----- PAW-WMS-DC</p> <p>Wall silent motion sensor 240 V AC.</p> <p>----- PAW-WMS-AC</p>	 <p>Ceiling silent motion sensor 24 V.</p> <p>----- PAW-CMS-DC</p> <p>Ceiling silent motion sensor 240 V AC.</p> <p>----- PAW-CMS-AC</p>	 <p>Power supply 24 V.</p> <p>----- PAW-24DC</p>	 <p>Door or window contact.</p> <p>----- PAW-DWC</p>
---	---	---	--

Centralised controls

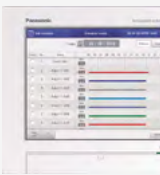
 <p>System controller for 64 indoor units with weekly timer.</p> <p>----- CZ-64ESMC3</p>	 <p>Central ON / OFF controller, up to 16 groups, 64 indoor units.</p> <p>----- CZ-ANC3</p>	 <p>Intelligent controller (touch screen/web server) to control up to 256 indoors with included load distribution ratio (LDR).</p> <p>----- CZ-256ESMC3</p>
--	---	---

Panasonic AC Smart Cloud



+ ALL REFERENCES RELATED TO AC SMART CLOUD IS IN THE DEDICATED PAGE

Panasonic AC Smart Cloud. Cloud internet control. Up to 128 groups. Controls 128 units.

CZ-CFUSCC1

BMS interface with S-Link



A unified interface supporting Modbus, BACnet, and KNX protocols for up to 16 indoor units.

PAW-AC2-BMS-16

A unified interface supporting Modbus, BACnet, and KNX protocols for up to 64 indoor units.

PAW-AC2-BMS-64

A unified interface supporting Modbus, BACnet, and KNX protocols for up to 128 indoor units.

PAW-AC2-BMS-128

Accessories interfaces

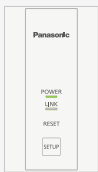

Commercial Wi-Fi Adaptor.

CZ-CAPWFC2



KNX interface (Intesis).

PAW-RC2-KNX-1i



Modbus RTU interface (Intesis).

PAW-RC2-MBS-1



Modbus RTU interface to control 4 indoor/ groups (Intesis).

PAW-RC2-MBS-4



BACnet IP and MSTP (Intesis).

PAW-RC2-BAC-1



KNX interface (Airzone).

PAW-AZRC-KNX-1



Modbus RTU interface (Airzone).

PAW-AZRC-MBS-1



BACnet IP and MSTP interface (Airzone).

PAW-AZRC-BAC-1















RAC interface adapter for integration into S-Link, plus external input and alarm/ status output (for YKEA units).

CZ-CAPRA1

Centralised controls. Connection with general equipment

 <p>Adaptor for ON / OFF control of external devices.</p> <p>----- CZ-CAPC3</p>	 <p>Mini series parallel device controlling indoor units, maximum 1 group and 8 indoor unit.</p> <p>----- CZ-CAPBC2</p>	 <p>Communication Adaptor. Up to 128 groups. Controls 128 units.</p> <p>----- CZ-CFUNC2</p>
---	---	---

Individual controls

 <p>CONEX wired remote controller (non-wireless), white.</p> <p>----- CZ-RTC6W</p>	 <p>CONEX wired remote controller with Bluetooth®, white.</p> <p>----- CZ-RTC6WBL</p>	 <p>CONEX wired remote controller with Wi-Fi and Bluetooth®, white.</p> <p>----- CZ-RTC6WBLW2</p>	 <p>CONEX wired remote controller (non-wireless), black.</p> <p>----- CZ-RTC6</p>
 <p>CONEX wired remote controller with Bluetooth®, black.</p> <p>----- CZ-RTC6BL</p>	 <p>CONEX wired remote controller with Wi-Fi and Bluetooth®, black.</p> <p>----- CZ-RTC6BLW2</p>	 <p>Design Wired remote controller with Econavi function.</p> <p>----- CZ-RTC5B</p>	 <p>Infrared remote controller for wall-mounted.</p> <p>----- CZ-RWS3</p>
 <p>Infrared remote controller and receiver for 4 way 60x60 cassette - PY3 with panel.</p> <p>----- CZ-RWS3 + CZ-RWRY3</p>	 <p>Infrared remote controller and receiver for 4 way 90x90 cassette.</p> <p>----- CZ-RWS3 + CZ-RWRU3</p>	 <p>Infrared remote controller and receiver for ceiling.</p> <p>----- CZ-RWS3 + CZ-RWRT3</p>	 <p>Infrared remote controller and receiver for all indoor units.</p> <p>----- CZ-RWS3 + CZ-RWRC3</p>

PanClima

Air Conditioning & Heating Systems

Γραφεία Αθήνας
Λεωφόρος Βουλιαγμένης 564 Άλιμος
174 56 Αθήνα Τ 216 800 90 90

Γραφεία Θεσσαλονίκης
Philippos Business Center Αγ. Αναστασίας 8 & Λαέρτου Πυλαία
555 35 Θεσσαλονίκη Τ 2316 004 020
e-mail: info@panclima.gr • www.panclima.gr

heating & cooling solutions



www.aircon.panasonic.eu/GR_el/

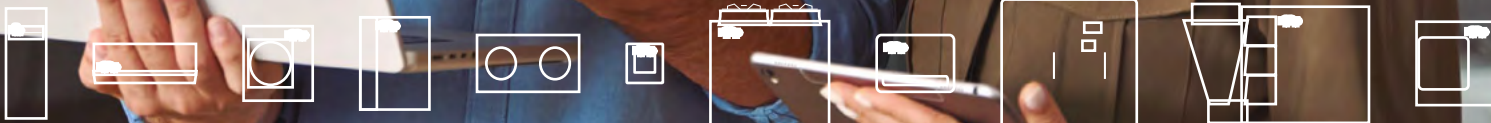

Panasonic

heating & cooling solutions